

KOMATSU®

D61EXi-24 **D61PXi-24** Tier 4 Final Engine

CRAWLER DOZER

D61i



intelligent | 2.0
MACHINE CONTROL

Photos may include optional equipment.

NET HORSEPOWER

168 HP @ 2200 rpm
125 kW @ 2200 rpm

OPERATING WEIGHT

D61EXi-24: 41,094 lb 18640 kg
D61PXi-24: 43,167 lb 19580 kg

BLADE CAPACITY

D61EXi-24: 4.41 yd³ 3.37 m³
D61PXi-24: 4.98 yd³ 3.81 m³

WALK-AROUND

Next-generation intelligence

Improved machine efficiency for work ranging from heavy dozing to finish grading with intelligent Machine Control technologies.

Lift layer control

Realizes consistent lift layers with automatic control.

Quick surface creation

Makes design data by easy operation.

Proactive dozing control

Cut and carry work smooth as if performed by experienced operator.

Tilt steering control

Relieves operator of correction operation toward target point.

Adopts two antennas supporting multiple global navigation satellite system (GNSS)

Improved reliability in work accuracy due to stable receiving of satellite signals.

Information and communication technology (ICT) system installed as standard before shipment

Improved reliability and durability.



Photo may include optional equipment.

NET HORSEPOWER

168 HP @ 2200 rpm
125 kW @ 2200 rpm

OPERATING WEIGHT

D61EXi-24: 41,094 lb 18640 kg
D61PXi-24: 43,167 lb 19580 kg

BLADE CAPACITY

D61EXi-24: 4.41 yd³ 3.37 m³
D61PXi-24: 4.98 yd³ 3.81 m³

D61EXi/PXi-24

INNOVATIVE. INTEGRATED. INTELLIGENT.



Standard intelligent Machine Control 2.0
Standard factory-installed integrated 3D
GNSS intelligent machine control system.

Improved Machine Control
Up to 8% more efficient dozer operation
than comparable aftermarket machine
control systems in start to finish
grading tests.

Factory Installed Machine Control Components

Machine control components are factory installed and designed as an integral part of the base machine for improved durability.

Komatsu Quality

Machine control components and system validated to Komatsu's rigorous quality & durability standards.

Industry Standard Compatibility

Machine control system makes use of common industry design data file norms and supports typical base station communication.

Simple Operator Interface

Simple touch screen control box with multi-color customizable display.

3D GNSS Machine Control Standard

All on-machine components standard including control box, GNSS receiver/radio, GNSS antenna, and enhanced inertial measuring unit sensor.

Finish Grade Performance

Enhanced sensor package and intelligent logic provides for finish grade accuracy in an integrated system without traditional blade mounted sensors.

Enhanced Inertial Measuring Unit (IMU+)

Chassis mounted enhanced inertial measuring unit (IMU+) and intelligent logic provides for finish grade accuracy without blade mounted sensors.

Dual Cab Top GNSS Antennas

Load control intelligence controls blade elevation to improve productivity and minimize track slip by adjusting blade load. 1.0' from grade or 0.1' from grade – you can run in auto mode.

Intelligent Dozing Mode Settings

Operators are able to select between 4 distinct machine control operating modes to optimize performance to the application whether cutting, spreading, or other.

Operator Selectable Load Settings

Machine control load settings can be adjusted between presets to tailor response to material conditions.

New Komatsu SAA6D107E-3, variable geometry, turbocharged and aftercooled, 6.8 liter diesel engine is EPA Tier 4 Final emissions certified.

Fluid Neutral or Better

Fuel & DEF TOTAL consumption is less than the fuel consumed by the prior model.

New Komatsu Diesel Particulate Filter (KDPF) and Selective Catalytic Reduction (SCR) systems reduce particulate matter and NOx, while

providing automatic regeneration that does not interfere with daily operation.

New higher performance Variable Geometry Turbocharger (VGT)

uses a hydraulic actuator to provide optimum air flow under all speed and load conditions.

Komatsu auto idle shutdown helps reduce excessive idle time.

Auto Engine Idle reduces machine to low idle during times of inactivity.

Rear Hydraulics (Standard)

Rear View Monitoring System (Standard)

New Large Color Monitor:

- Easy-to-read large 7" high-resolution multi-color monitor
- Easy-to-use multiple tabular menus
- Easy-to-use onboard diagnostics that don't require a laptop
- Ecology guidance

Integrated ROPS Cab Features:

- Large, quiet, pressurized cab
- Excellent visibility with integrated ROPS structure
- Air suspension high-capacity heated seat

New high-engine-RPM (H) mode helps maintain ground speed during heavy blade load applications.

Parallel Link Undercarriage System (PLUS) provides up to double the wear life and lowers repair and maintenance costs.

Triple labyrinth final drive provides additional protection for the final drive floating seals.

INTELLIGENT MACHINE CONTROL

D61EXi/PXi-24



intelligent Machine Control (iMC) 2.0

D61EXi/PXi-24 utilizes intelligent Machine Control 2.0 a GNSS* system that automatically controls the blade to 3-dimensional design data. Machine Control 2.0 utilizes the industry's first Proactive Dozing Control logic, lift layer control, quick surface creation, and tilt steering control. A two-antenna system supporting multiple GNSS, which provides less downtime and more work time. These added features make for improved production and efficiency.

*GNSS (Global Navigation Satellite System): General term for satellite positioning systems such as GPS, GLONASS, etc.

Quick surface creation

Operators can create a temporary design surface with the press of a button. Designed to simplify in-field surface creation within the control box, it allows for more utilization of iMC 2.0.



Tilt steering control

The blade automatically tilts under a heavy load to maintain a straight line of travel, optimizing productivity throughout each pass and reducing operator fatigue.



Auto/manual switch

A conveniently located on/off switch giving the operator control of when iMC 2.0 is active.



Function switches

Cut/fill offset switch

The target surface height can be quickly adjusted by pressing the offset switch (button).

Back grade mode switch

Allows for automatic control during back grading.

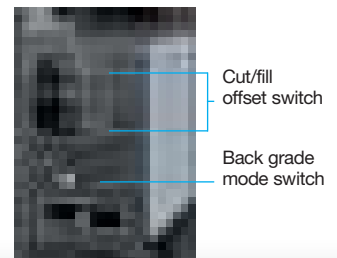

Lift layer control

Optimize earthwork productivity and maintain compaction quality by automatically controlling lifts to the desired heights with respect to the mapped terrain. Excess fill is eliminated as automatic blade control will follow finish surface once lifts have reached finish grade.

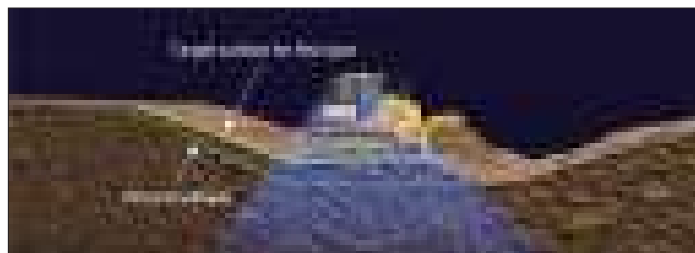

Proactive dozing control

Operators can utilize automatic blade control from rough grading to finish grading work. Proactive dozing control understands the terrain in the path of each cut, maximizes the blade load throughout the pass, regardless of the terrain ahead, and achieves productivity similar to that of an experienced operator.

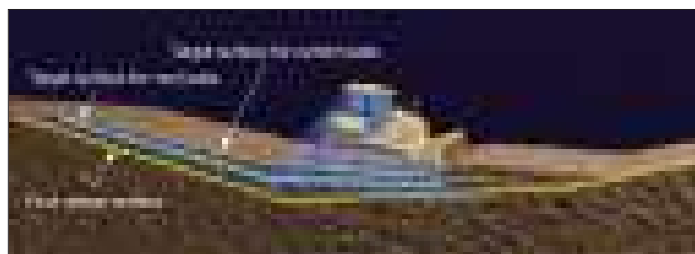

Two antennas supporting multiple GNSS

Work accuracy is improved by two antennas supporting the multiple GNSS.

Improvement of blade accuracy on slope

Blade accuracy is maintained during slope work.

Reliability of blade accuracy

Galileo, QZSS, and BeiDou can be used in addition to GPS and GLONASS. Since the satellite capture rate is improved, the machine can be used in any time zone.

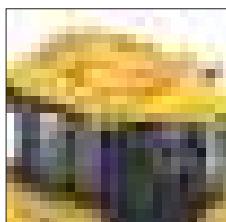

Control box

- 1 L.H. LED indicator
- 2 R.H. LED indicator
- 3 Power ON/OFF and menu switch (Press: Display the main menu / Hold down: Turn ON/OFF the power supply)
- 4 Zoom in switch
- 5 Toggle main view switch (Press: Switch the display of main window (Hold down): Adjust the brightness and sound volume)
- 6 Left window
- 7 Right window
- 8 Middle window
- 9 Lower window
- 10 Speed control ON/OFF
- 11 Tilt in top slot
- 12 Cut depth selection
- 13 Simple grading ON/OFF
- 14 Toggle start ON/OFF
- 15 Tilt steering ON/OFF
- 16 Toggle Auto-tilt mode (range view is (front), (out W), (press count))
- 17 Quick surface creation (Create slope plane surface)
- 18 Lift layer control (Disable Auto-tilt design surface)
- 19 Elevation control key
- 20 Slope control key
- 21 GNSS status
- 22 Radio status
- 23 GNPS offset
- 24 Cut/Fill reading
- 25 Tilt of blade
- 26 Design cross-slope
- 27 Type of control
- 28 AUTO indicator
- 29 Back Guide main indicator
- 30 Lift indicator
- 31 Upper LED indicator

*This is a typical main screen of control box.

PERFORMANCE FEATURES

KOMATSU NEW ENGINE TECHNOLOGIES

Komatsu's New Emission Regulations-compliant Engine

New regulations effective in 2014 require the reduction of NOx emissions. In addition to refining the Tier 4 Interim technologies, Komatsu developed a new Selective Catalytic Reduction (SCR) device in-house.

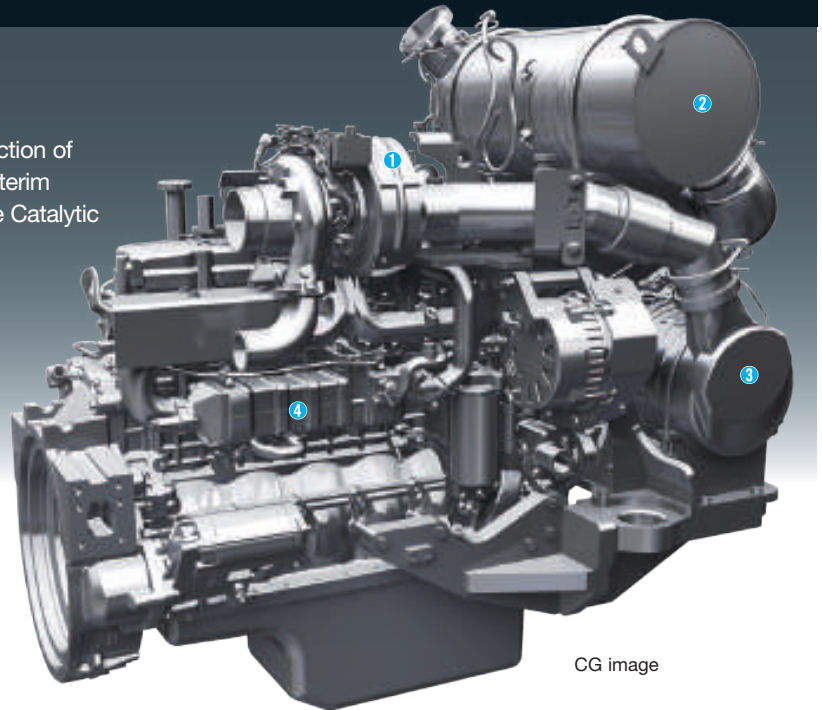

CG image

- 1 Variable Geometry Turbocharger (VGT)
- 2 Selective Catalytic Reduction (SCR)
- 3 Komatsu Diesel Particulate Filter (KDPF)
- 4 Exhaust Gas Recirculation (EGR) cooler

Technologies Applied to the New Engine Heavy-Duty Aftertreatment System

This new system combines a Komatsu Diesel Particulate Filter (KDPF) and Selective Catalytic Reduction (SCR). The SCR NOx reduction system injects the correct amount of DEF at the proper rate, transforming NOx into non-toxic water (H₂O) and nitrogen gas (N₂).

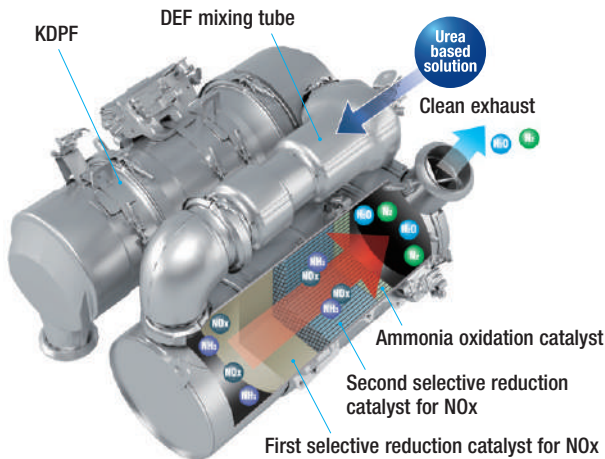

Advanced Electronic Control System

The electronic control system performs high-speed processing of all signals from sensors installed in the vehicle, providing total control of equipment in all conditions. Engine condition information is displayed via an on-board network to the monitor inside the cab, providing necessary information to the operator. Additionally, managing the information via KOMTRAX helps customers keep up with required maintenance.

Variable Geometry Turbocharger (VGT) system

The VGT system features proven Komatsu design hydraulic technology for variable control of air-flow and supplies optimal air according to load conditions. It provides better exhaust temperature management. The Tier 4 final version has an improved propeller design for increased performance.

Heavy-Duty Cooled Exhaust Gas Recirculation (EGR) System

The system recirculates a portion of exhaust gas into the air intake and lowers combustion temperatures, thereby reducing NOx emissions. EGR gas flow has been decreased for Tier 4 Final with the addition of SCR technology. The system achieves a dynamic reduction of NOx, while helping reduce fuel consumption below Tier 4 Interim levels.

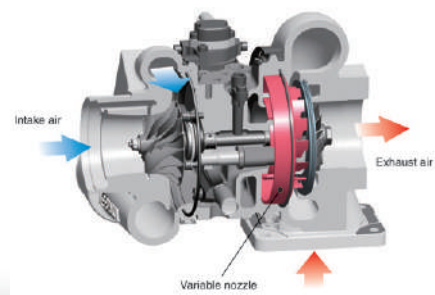
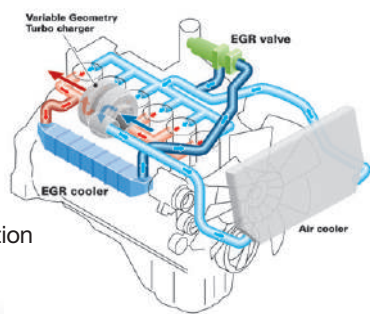

Heavy-Duty High-Pressure Common Rail (HPCR) Fuel Injection System

The system is designed to achieve an optimal injection of high-pressure fuel by means of computerized control, providing close-to-complete combustion to reduce PM emissions. The system uses high pressure injection, thereby reducing both PM emissions and fuel consumption over the entire range of engine operating conditions. The Tier 4 Final engine has advanced fuel injection timing for reduced fuel consumption and lower soot levels.

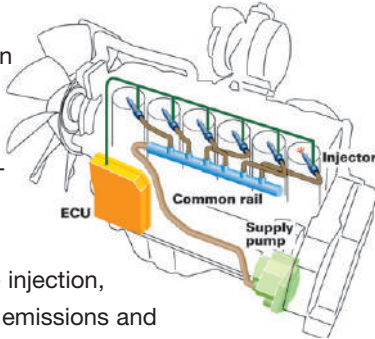

Komatsu Closed Crankcase Ventilation (KCCV)

The KCCV efficiency is significantly increased from previous models from approximately 50% to 95% efficiency.



Komatsu Auto Idle Shutdown

Komatsu auto idle shutdown automatically shuts the engine down after idling for a set period of time to reduce unnecessary fuel consumption and exhaust emissions. The amount of time before the engine is shutdown can be programmed easily from 5 to 60 minutes.

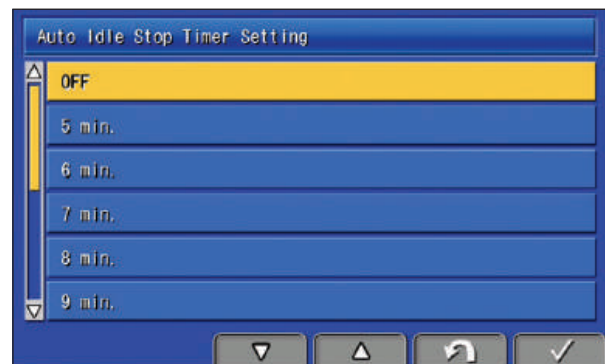

Redesigned combustion chamber at top of piston

The combustion chamber at the top of the piston has an optimized shape designed to improve combustion and further reduce NOx, particulate matter, fuel consumption and noise.



PRODUCTIVITY & FUEL ECONOMY FEATURES

HYDROSTATIC TRANSMISSION (HST) CONTROL SYSTEM

Hydrostatic Transmission (HST) control system

The HST controller monitors engine output and work load. It controls HST pump and motor displacement to provide the optimum speed and drawbar pull. Full power to both tracks during turns or counter-rotation makes the D61EXi/PXi-24 extremely maneuverable.



Fuel Efficiency

The efficient HST control system can reduce fuel consumption.

Hydraulically Driven Cooling Fan

The engine cooling fan's speed is electronically controlled. Fan speed depends on engine coolant and oil temperatures. The fan will only rotate as fast as necessary to adequately cool the machine's fluid. This system increases fuel efficiency, reduces operating noise levels and uses less horsepower than a belt-driven fan.

Long Track-On-Ground and Oscillating Track Frame

Long machine track-on-ground and oscillating track frames improve stability and grading/dozing performance.

Selectable Working Mode

P mode is designed for powerful operation and maximum production. E mode is designed for general dozing applications, providing adequate speed and power, while saving energy. For fuel reduction and energy saving, the monitor panel allows the operator to switch the working mode easily, depending on the work at hand.

P mode (Power mode)

With P mode, the engine runs full power, allowing the machine to perform the work requiring large production, heavy loads and uphill work.

E mode (Economy mode)

With E mode, the engine uses enough power for the work, without delivering unnecessary power. This mode enables energy saving operation. It is ideal on hard or rough surfaces that often cause shoe slip, and work requiring less power, such as downhill dozing, leveling and light-load work.

New H mode (high engine idle speed mode)

This setting allows subtle changes in load to be detected, which is tailor-made for power-intensive work. Compared to P mode, the engine high-idle speed is higher in H mode.

PAT DOZER

PAT Dozer with Adjustable Pitch

A power angle power tilt dozer blade with adjustable blade pitch system is available. This blade is available for the D61EXi/PXi-24 machines. The hydraulic blade tilt, angling function (and manually adjustable blade pitch) add versatility and productivity in a variety of applications.



Increased Wear Life Blade Skin

The hardness of the blade skin has been improved for increased wear life.

Unrivaled Blade Visibility

The D61EXi/PXi-24 incorporates Komatsu's super-slant nose design. Komatsu's innovative design provides excellent blade visibility for improved machine control and increased efficiency and productivity.

Tie Off Points Standard (ISO 14567)

When working in elevated positions, four tie off points (1 at each corner of the cab) provide anchors for technician harness lanyards.

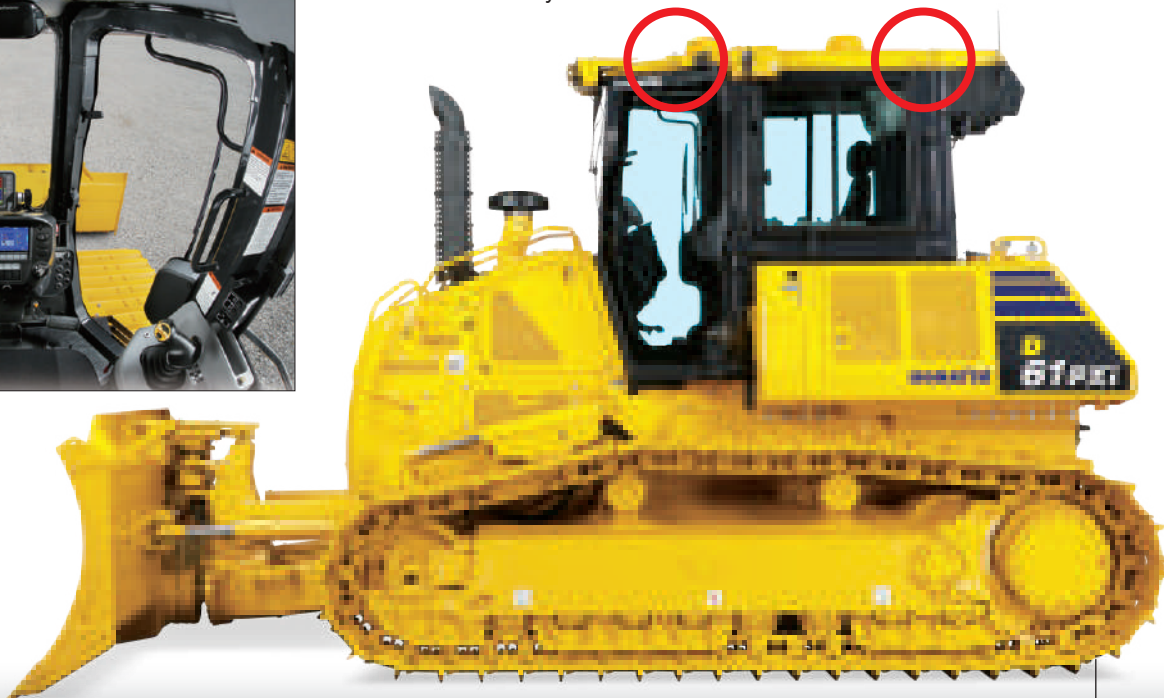

CONTROL FEATURES



Palm Command Control System (PCCS) Levers

Komatsu's ergonomically-designed PCCS handles create an operating environment with complete operator control.

PCCS

The low-effort PCCS joystick controls all directional movements, including machine travel speed as well as counter-rotation.

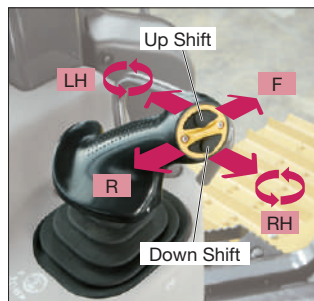

Electronic Controlled Hydraulic System

The electronic controlled, palm commanded joystick provides precise blade control. New blade angling switch operation provides easier and predictable blade control.

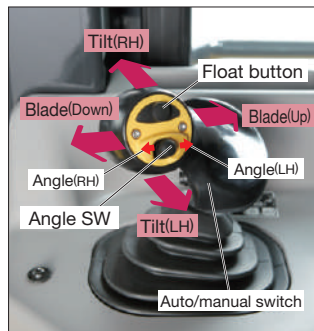

Hydrostatic Transmission with Electronic Control

The D61EXi/PXi-24 is equipped with Komatsu-designed HST that allows for quick-shift or variable speed selection. The HST features dual-path closed-circuits with two variable displacement piston pumps and two variable displacement travel motors. Hydrostatic steering eliminates steering clutches and brakes, providing smooth powerful turns. Fully electronic control provides full automatic shifting and enables smooth control. An electronic fuel control dial controls engine speed.

One-Pedal Design (Decelerator/Brake Pedal) Controls Speed, During Operation

Machine operation is simple due to brake function integration into the decelerator pedal.

Machine travel speed can be controlled using one pedal. The pedal function can be changed by a mode selector switch.

Decelerator mode: The pedal can decelerate engine rpms and vehicle travel speed. It can be used for all applications.

Brake mode: The pedal can decelerate vehicle travel speed while maintaining high-engine speed. This mode can be helpful to maintain work-equipment speed, while using the brake function.



WORKING ENVIRONMENT



Integrated ROPS (ISO 3471) Cab

The D61EXi/PXi-24 has an integrated ROPS (ISO 3471) cab. High rigidity and superb sealing performance sharply reduce noise and vibration for the operator and discourage dust from entering the cab. In addition, side visibility is increased because external ROPS (ISO 3471) structure and posts are not required.



Comfortable Ride with Heated Operator Seat

The operator seat has adjustable lumbar support, tilt and an electric heater. It is easy to adjust to the operator's shape. Also, standard seat heat makes it possible to work comfortably in the winter.



Comfortable Ride with Cab Damper Mounting

The D61EXi/PXi-24's cab mount uses a cab damper system that provides shock and vibration absorption conventional mounting systems cannot match. The silicon-oil-filled cab damper mount helps to isolate the cab from the machine body, suppressing vibration and providing a quiet, comfortable operating environment.

Auxiliary Input Jack & Two Electrical Outlets

By connecting an auxiliary device to this plug input, the operator can play audio from a mobile device through the machine's sound system. Two DC 12 volt electrical outlets provide a power source for a radio or other equipment.



Two DC12 V electrical outlets

Auxiliary input jack

ADDITIONAL OPERATOR CONVENIENCE EQUIPMENT

Rear view monitor system

On the large LCD color monitor, the operator can view, through one camera, areas directly behind the machine. This camera can be synchronized with reverse operation.



Secondary engine shutdown switch

A secondary switch has been added at the side of the front console to shut down the engine.



RELIABILITY & MAINTENANCE FEATURES

Excellent Reliability & Durability

Parallel Link Undercarriage System (PLUS)

Komatsu's PLUS provides less downtime and longer wear, with up to 40% lower undercarriage maintenance costs. Rotating bushings eliminate the cost and downtime of bushing turns, and strengthened rollers and links increase wear life by up to 100 percent. With PLUS, individual links can be replaced with common track tools.

Modular design

One of the design goals behind the creation of the D61EXi/PXi-24 was to manufacture a more durable machine. This was achieved by reducing component complexity and using a strong modular design for increased serviceability and durability. Steel castings reduce the number of welds, improving rigidity and strength.

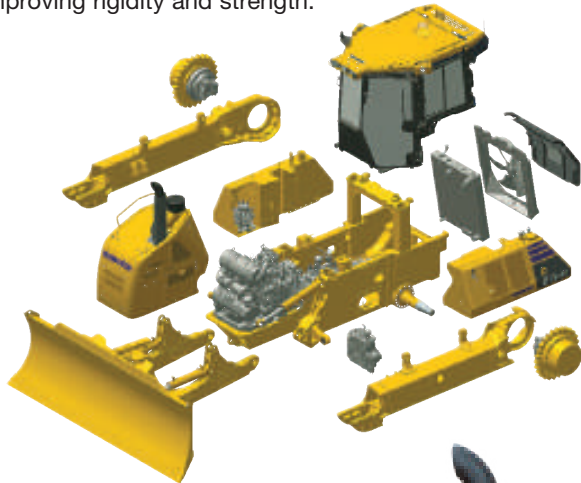

Self-adjusting idler support

The self-adjusting idler support provides constant and even tension on idler guide plates reducing noise and vibration and increasing undercarriage life.

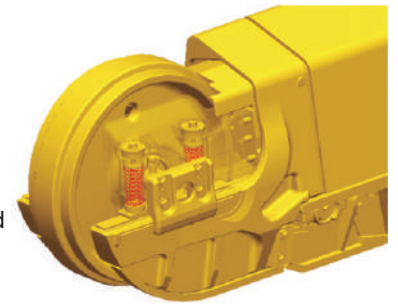

Easy Maintenance

Planned maintenance and daily checks are the only way to ensure long service life from equipment. That's why Komatsu designed the D61EXi/PXi-24 with conveniently located maintenance 980E-5 Specification Sheet (AESS932-00) to make necessary inspections and maintenance quick and easy.

Hydraulically-driven swing-up fan

The D61EXi/PXi-24 utilizes a swing-up fan with a gas strut-assisted lift system to provide easy access to the (side-by-side) radiator, oil cooler and charge air cooler. The hydraulic fan has a cleaning mode which can be used for periodic cooler cleaning.



D61EXi/PXi-24

TECHNOLOGY FEATURES



Large Multi-Lingual High Resolution LCD Monitor

A large, user-friendly color monitor provides easy-to-understand information for the operator. Excellent screen visibility is achieved with a high resolution LCD monitor that is easy to read at various angles and lighting conditions. Easy-to-operate switches and function keys simplify multi-function operations. The monitor displays data in 26 languages.



Multi-Monitor with Troubleshooting Function to Minimize Down Time

Various meters, gauges and warning functions are centrally arranged on the multi-monitor. The monitor simplifies start-up inspection and promptly warns the operator with a lamp and buzzer if any abnormalities occur. In addition, countermeasures are indicated in 4 levels to help prevent major machine issues. Replacement times for required planned maintenance services are also indicated.



Energy Saving Operation

Ecology guidance

In order to support efficient operation, the following four messages are displayed for fuel saving operation. These can be disabled by the operator, if desired.

- 1) Avoid Excessive Engine Idling
- 2) Use Economy Mode to Save Fuel
- 3) Avoid Hydraulic Relief Pressure
- 4) Avoid Over Load

Ecology gauge Ecology guidance



Fuel consumption display

Ecology gauge

To help the operator perform more efficiently and minimize energy consumption, an easy-to-read "ecology gauge" is displayed on the left of the multi-monitor screen.

Fuel consumption display

Average fuel consumption during the day is displayed and updated every 10 seconds.

Ecological Operation Report for Assistance

KOMTRAX® is Komatsu's remote equipment and fleet monitoring system. Wireless technology and a secure Web-based application offers the information needed to make the best possible operation and management decisions. From location, actual hours worked, and fuel consumption to maintenance monitoring, abnormality codes, and load frequency, KOMTRAX creates reports that are easy to read and understand. The new D61EXi/PXi-24 adds the following new information for fuel consumption reduction.

- Guidance to improve fuel consumption
- Ecological operation report
- Report operation hours by operation mode (E, P, or H mode)

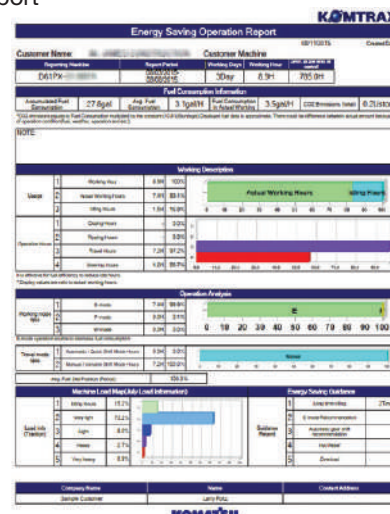

KOMATSU PARTS & SERVICE SUPPORT



Komatsu CARE®

Program Includes:

*The D61EXi/PXi-24 comes standard with complimentary factory scheduled maintenance for the first 3 years or 2,000 hours, whichever occurs first.

Planned Maintenance Intervals at:

500/1000/1500/2000 hour intervals. (250 hr. initial interval for some products) Complimentary Maintenance Interval includes: Replacement of Oils & Fluid Filters with genuine Komatsu Parts, 50-Point inspection, Komatsu Oil & Wear Analysis Sampling (KOWA) / Travel & Mileage (distance set by distributor; additional charges may apply).

Benefits of Using Komatsu CARE

- Assurance of Proper Maintenance with OEM Parts & Service
- Increased Uptime & Efficiency
- Factory Certified Technicians Performing Work
- Cost of Ownership Savings
- Transferable Upon Resale

Complimentary KDPF Exchanges

The D61EXi/PXi-24 comes standard with 2 Complimentary KDPF Exchange Units for the first 5 years or 9,000 hours whichever occurs first. The suggested KDPF Exchange unit service intervals are 4,500 hours & 9,000 hours. End user must have authorized Komatsu distributor perform the removal & installation of the KDPF.

Complimentary SCR Maintenance

The D61EXi/PXi-24 also includes 2 factory suggested services of the Selective Catalytic Reduction (SCR) Diesel Exhaust Fluid (DEF) system during the first 5 years or 9,000 hours whichever occurs first. The service includes factory suggested DEF tank flush & strainer cleaning at the suggested service intervals of 4,500 hours & 9,000 hours.

KOMATSU CARE D61EXi/PXi-24

Interval PM	500	1000	1500	2000
KOWA SAMPLING – (Engine, Hydraulics, L & R Final Drives)	✓	✓	✓	✓
LUBRICATE MACHINE, INCLUDING EQUALIZER BAR CENTER AND SIDE PINS	✓	✓	✓	✓
CHANGE ENGINE OIL	✓	✓	✓	✓
REPLACE ENGINE OIL FILTER	✓	✓	✓	✓
REPLACE FUEL PRE-FILTER	✓	✓	✓	✓
REPLACE A/C FRESH & RECIRCULATION FILTERS	✓	✓	✓	✓
DRAIN SEDIMENT FROM FUEL TANK	✓	✓	✓	✓
CLEAN AIR CLEANER ELEMENT	✓	✓	✓	✓
COMPLETE 50 POINT INSPECTION FORM; LEAVE PINK COPY WITH CUSTOMER OR IN CAB	✓	✓	✓	✓
RESET MONITOR PANEL MAINTENANCE COUNTER FOR APPROPRIATE ITEMS	✓	✓	✓	✓
REPLACE FUEL MAIN FILTER		✓		✓
REPLACE FUEL TANK BREATHER ELEMENT		✓		✓
REPLACE HYDRAULIC TANK BREATHER ELEMENT		✓		✓
CHANGE FINAL DRIVE OIL		✓		✓
CHANGE HYDRAULIC OIL				✓
REPLACE HYDRAULIC FILTER				✓
REPLACE HST FILTER				✓
REPLACE KCCV FILTER				✓
CLEAN HYDRAULIC TANK STRAINER				✓
FACTORY TRAINED TECHNICIAN LABOR	✓	✓	✓	✓
2 KDPF Exchanges suggested at 4,500 Hrs and 9,000 Hrs.				
2 SCR System Maintenance Services suggested at 4,500 Hrs. and 9,000 Hrs.				

Komatsu CARE® – Advantage Extended Coverage

- Extended Coverage can provide peace of mind by protecting customers from unplanned expenses that effect cash flow
- Purchasing extended coverage locks-in the cost of covered parts and labor for the coverage period and helps turn these into fixed costs



Komatsu Parts Support

- 24/7/365 to fulfill your parts needs
- 9 parts Distribution Centers strategically located across the U.S. and Canada
- Distributor network of more than 300 locations across U.S. and Canada to serve you
- Online part ordering through Komatsu eParts
- Remanufactured components with same-as-new warranties at a significant cost reduction



Komatsu Oil and Wear Analysis (KOWA)

- KOWA detects fuel dilution, coolant leaks, and measures wear metals
- Proactively maintain your equipment
- Maximize availability and performance
- Can identify potential problems before they lead to major repairs
- Reduce life cycle cost by extending component life

* Certain exclusions and limitations apply. Refer to the customer certificate for complete program details and eligibility. Komatsu® and Komatsu Care® are registered trademarks of Komatsu Ltd. Copyright 2017 Komatsu America Corp.

D61EXi/PXi-24

KOMTRAX EQUIPMENT MONITORING

intelligent / 2.0
MACHINE CONTROL

GET THE WHOLE STORY WITH
KOMTRAX[®]

✓ WHAT

- KOMTRAX is Komatsu's remote equipment monitoring and management system
- KOMTRAX **continuously monitors and records** machine health and operational data
- Information such as fuel consumption, utilization, and a detailed history **lowering owning and operating cost**
- KOMTRAX is **standard** equipment on all Komatsu construction products

✓ WHEN

- Know when your machines are **running or idling** and make decisions that will improve your fleet utilization
- Detailed movement records ensure you know when and where your equipment is moved
- Up to date records allow you to **know when maintenance is due** and help you plan for future maintenance needs

✓ WHERE

- KOMTRAX data **can be accessed virtually anywhere** through your computer, the web or your smart phone
- Automatic alerts keep fleet managers up to date on the latest machine notifications

✓ WHY

- Knowledge is power - **make informed decisions** to manage your fleet better
- Knowing your idle time and fuel consumption will help maximize your machine efficiency
- **Take control of your equipment** - any time, anywhere



KOMTRAX[®]

For construction and compact equipment.

SPECIFICATIONS



ENGINE

Model..... Komatsu SAA6D107E-3*
 Type..... 4-cycle, water-cooled, direct injection
 Aspiration..... Komatsu Variable Geometry
 Turbocharged, air-to-air aftercooled, cooled EGR
 Number of cylinders..... 6
 Bore x stroke..... 107 mm x 124 mm **4.21" x 4.88"**
 Piston displacement..... 6.69 ltr **408 in³**
 Governor.....All-speed and mid-range, electronic
 Horsepower
 SAE J1995..... Gross 127 kW **170 HP**
 ISO 9249 / SAE J1349.....Net 125 kW **168 HP**
 Hydraulic fan at maximum speed..... Net 113 kW **152 HP**
 Rated rpm.....2200 rpm
 Fan drive type.....Hydraulic
 Lubrication system
 Method.....Gear pump, force lubrication
 Filter..... Full-flow

*EPA Tier 4 Final emissions certified



HYDROSTATIC TRANSMISSION

Dual-path, hydrostatic transmission provides infinite speed changes up to 9.0 km/h **5.6 mph**. The variable capacity travel motors allow the operator to select the optimum speed to match specific jobs. Travel control lock lever and neutral switch.

Travel speed (quick shift mode)*	Forward	Reverse
1st	0-3.4 km/h 0-2.1 mph	0-4.1 km/h 0-2.5 mph
2nd	0-5.6 km/h 0-3.5 mph	0-6.5 km/h 0-4.0 mph
3rd	0-9.0 km/h 0-5.6 mph	0-9.0 km/h 0-5.6 mph

Travel speed (variable mode)	Forward	Reverse
	0-9.0 km/h 0-5.6 mph	0-9.0 km/h 0-5.6 mph

*Quick shift speeds are adjustable in the monitor.

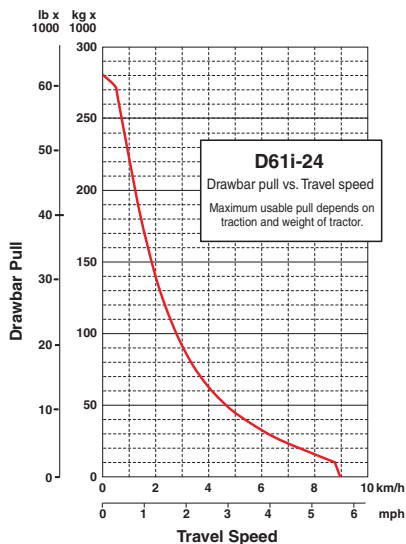

FINAL DRIVES

In-shoe mounted axial piston type travel motors with integrated two-stage planetary gear reduction. Compact in-shoe mount reduces risk of damage by debris. Bolt-on sprocket for easy displacement.



STEERING SYSTEM

PCCS joystick control for all directional movements. Pushing the joystick forward results in forward machine travel, while pulling it backward reverses the machine. Simply tilt the joystick to the left or right to make a turn. Tilting the joystick fully to the left or right activates counter-rotation. HST eliminates steering clutches and brakes, providing smooth, powerful turns. Fully electronic control enables smooth operation. The PCCS utilizes shift buttons to increase and decrease speed.

Minimum turning radius
 D61EXi-24 2.1 m **83"**
 D61PXi-24 2.3 m **91"**



UNDERCARRIAGE

Suspension..... Oscillating-type with equalizer bar and pivot shafts
 Track roller frameMonocoque, large section, durable construction
 Rollers and idlersLubricated track rollers

Lubricated tracks
 Parallel Link Undercarriage System (PLUS) with lubricated rotating bushings for extended system wear life and lower maintenance costs. Track tension is adjusted easily with grease gun.

	D61EXi-24	D61PXi-24
Number of track rollers (each side)	8	8
Type of shoes (standard)	Single grouser	Single grouser
Number of shoes (each side)	46	46
Grouser height	mm in 57.5 2.3"	57.5 2.3"
Shoe width (standard)	mm in 600 24"	860 34"
Ground contact area	cm ² 37980	54440
	in² 5,887	8,438
Ground pressure	kPa 43.37	31.78
(with dozer, ROPS cab)	kgf/cm ² 0.44	0.32
	psi 6.29	4.61
Track gauge	mm ft.in 1900 6'3"	2130 7'0"
Length of track on ground	mm ft.in 3165 10'5"	3165 10'5"



SERVICE REFILL CAPACITIES

Coolant 45 ltr **11.9 U.S. gal**
 Fuel tank 372 ltr **98.3 U.S. gal**
 Engine oil 27 ltr **7.2 U.S. gal**
 Hydraulic tank 101 ltr **26.7 U.S. gal**
 Final drive (each side)..... 8.1 ltr **2.2 U.S. gal**
 DEF tank 20.6 ltr **5.4 U.S. gal**



OPERATING WEIGHT (APPROXIMATE)

Tractor weight:
 Including ROPS (ISO 3471) cab, C frame for PAT dozer, rated capacity of lubricant, coolant, full fuel tank, operator and standard equipment.

D61EXi-24..... 17650 kg **38,911 lb**
 D61PXi-24..... 18440 kg **40,653 lb**

Operating weight:
 Including PAT dozer, ROPS (ISO 3471) cab, operator, standard equipment, rated capacity of lubricant, coolant and full fuel tank.

D61EXi-24..... 18640 kg **41,094 lb**
 D61PXi-24..... 19580 kg **43,167 lb**



DIMENSIONS

	D61EXi-24		D61PXi-24	
A	3250 mm	10'8"	3860 mm	12'8"
B	435 mm	1'5"	515 mm	1'8"
C	1195 mm	3'11"	1155 mm	3'9"
D	1025 mm	3'4"	1025 mm	3'4"
E	580 mm	1'11"	580 mm	1'11"
F	3165 mm	10'5"	3165 mm	10'5"
G	5480 mm	17'12"	5480 mm	17'12"
H	3340 mm	11'	3340 mm	11'
I	57.5 mm	2"	57.5 mm	2"
J	1900 mm	6'3"	2130 mm	7'0"
K	610 mm	2'0"	860 mm	2'10"
L	2500 mm	8'2"	2990 mm	9'10"
M	2980 mm	9'9"	3530 mm	11'7"
N	6100 mm	20'0"	6220 mm	20'5"

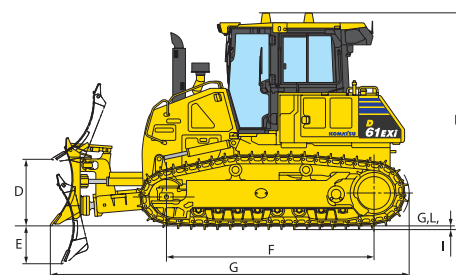
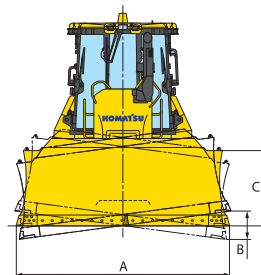
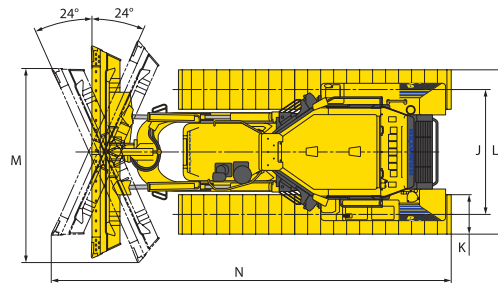

Ground clearance 390 mm **15"**



HYDRAULIC SYSTEM

Closed-Center Load Sensing System (CLSS) designed for precise and responsive control, and for efficient simultaneous operation.

Hydraulic control unit:

All spool control valves externally mounted remote to the hydraulic tank. Piston-type hydraulic pump with capacity (discharge flow) of 171 ltr/min **45 U.S. gal/min** at rated engine rpm.

Relief valve setting 27.4 MPa 280 kg/cm² **3,974 psi**
 Hydraulic cylinders Double-acting, piston type

	Number of cylinders	Bore
Blade lift	2	100 mm 4"
Blade tilt	1	120 mm 5"
Blade angle	2	110 mm 4"

Hydraulic oil capacity (refill):

Power angle tilt dozer 101 ltr **26.7 U.S. gal**

Control valves:

3-spool control valve for Power Angle Tilt dozer

Positions:

- Blade lift Raise, hold, lower, and float
- Blade tilt Right, hold, and left
- Blade angle Right, hold, and left

Additional control valve required for ripper

Positions:

- Ripper lift Raise, hold, and lower



DOZER EQUIPMENT

	Overall Length With Dozer mm ft.in	Blade Capacity m ³ yd ³	Blade Width x Height mm ft.in	Max. Lift Above Ground mm ft.in	Max. Drop Below Ground mm ft.in	Max. Tilt Adjustment mm ft.in
D61EXi-24	5480	3.4	3250 x 1195	1025	580	435
Power Angle Tilt Dozer	18'0"	4.5	10'8" x 3'11"	3'4"	1'11"	17"
D61PXi-24	5480	3.8	3860 x 1155	1025	580	515
Power Angle Tilt Dozer	18'0"	5.0	12'8" x 3'9"	3'4"	1'11"	20"

Blade capacities are based on the SAE recommended practice J1265. Use of high-tensile-strength steel in moldboard for strengthened blade construction.



STANDARD EQUIPMENT FOR BASE MACHINE*

- Air cleaner, double element with dust indicator
- Alternator, 90 ampere/24V
- Backup alarm
- Batteries, 200 Ah/2 x 12V
- Battery disconnect switch
- Blade lift cylinders
- Color monitor, LCD
- Curved exhaust pipe
- Decelerator pedal (single pedal)
- Engine hood
- Engine intake centrifugal precleaner
- Engine, swing open side cover
- Engine shutdown secondary switch
- Fluid sampling ports
- Front pull hook
- High mount foot rests
- Horn, warning
- Hydraulic driven radiator cooling fan with reverse clean mode
- Hydraulics for rear equipment
- intelligent Machine Control 2.0
- KOMTRAX®
- Komatsu Diesel Particulate Filter (KDPF)
- Locks, filler caps and covers
- Radiator mask, heavy-duty, swing up
- Radiator reserve tank
- Remote mounted equalizer bar greasing
- ROPS cab**
 - Air conditioner
 - Cab accessories
 - 12V power supply (2 ports)
 - Cup holder
 - Rearview mirror
 - Rear view monitoring (1 camera)
 - Bluetooth/USB compatible radio with remote AUX plug (3.5 mm)
 - 76 dBA
 - LED worklights
- Seat, air suspension, fabric, heated low back, headrest
- Seat belt, 76 mm **3"**, retractable
- Seat belt indicator
- Sealed electrical connectors
- Side-by-side rear mounted cooling package
- Starting motor, 5.5 kW/24V
- Steering system, hydrostatic
- Tie off points standard (ISO 14567)
- Track roller guards, center and end sections
- Track shoe assembly
 - Heavy-Duty lubricated rotary bushing (PLUS) track
 - 610 mm **24"** single grouser shoe (EX)
 - 860 mm **34"** single grouser shoe (PX)
- Transmission with variable and customizable quickshift
- Transmission, hydrostatic
- Underguards, heavy duty
 - Engine
 - Transmission
- Variable Geometry Turbocharger (VGT)
- Water separator

* Dozer assembly and rear mounted equipment are not included in base machine standard equipment

** Cab meets ROPS and FOPS Level 2 standards



OPTIONAL EQUIPMENT

- Dozer assembly
- Drawbar, long type
- Track roller guard, full length

Multi-shank ripper

Weight 1757 kg **3,874 lb**
 Beam length 2170 mm **7'1"**
 Maximum lift above ground 560 mm **1'10"**
 Maximum digging depth 665 mm **2'2"**

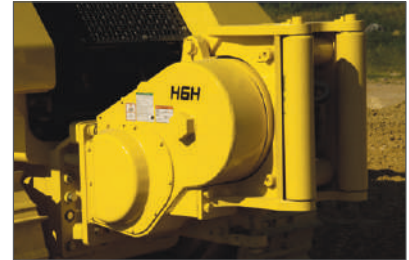

ALLIED MANUFACTURER'S ATTACHMENTS (SHIPPED LOOSE)

- Guarding - Komatsu (Ken Garner)
 - Front sweeps 260 kg **573 lb**
 - Hinged cab side screens 44 kg **97 lb**
 - Hinged cab rear screen 43 kg **95 lb**
 - Rear fan guard (HD) 12 kg **27 lb**
- Hydraulic winch - Allied H6H
1356 kg **2,990 lb**



Note: All comparisons and claims of improved performance made herein are made with respect to the prior Komatsu model unless otherwise specifically stated.