

KOMATSU

PC290LC-11/PC290LCi-11

Hydraulic excavator



Net horsepower

196 HP (147 kW) @ 2,050 rpm

Operating weight

70,702–72,091 lbs. (32,070–32,700 kg)

Bucket capacity

0.76–2.13 yd³ (0.58–1.63 m³)



Give your operators the power of advanced automation



Innovation



Performance



Efficiency



Command the latest technology with iMC 2.0

Empower your operators to work more efficiently than they ever could with conventional aftermarket machine guidance or manual operation. The PC290LCi-11 with intelligent Machine Control (iMC) offers the capability to work smart, from rough digging to finish grading. Incorporating a host of advanced, proprietary machine technology, iMC puts sophisticated, productivity-enhancing automation and cutting-edge job site design at your command.

- Semi-automatic for trenching, slope work and high production applications
- Minimize over-excavation and make every pass count

Perform finish grading using only arm input

Your operators can finish grade quickly and accurately with a bucket angle hold control that automatically holds the bucket angle to the design surface during arm operation, enabling operators to perform finish grading using only arm input.

Auto tilt bucket control

Auto tilt bucket control assists the operator in aligning the bucket parallel with the slope, so that finish grading can be accomplished without having to align the machine with the target surface.

Quick specs

- Weight: 70,702-72,091 lbs. (32,070-32,700 kg)
- Horsepower: 196 HP @ 2,050 rpm (147 kW @ 2,050 rpm)
- Bucket capacity: 0.76-2.13 yd³ (0.58-1.63 m³)



intelligent Machine Control (iMC)



Make every pass count

Improve your efficiency

iMC means fast excavation to finish grade.

Semi-automatic operation

New features such as bucket angle hold control provide high levels of accuracy and comfort.



Innovative

- Achieve highly accurate results with the iMC excavator's semi-automatic operation of work equipment
- Compact 10.4-in (26.4-cm) iMC monitor with increased memory capacity, processing speed, and pinch-to-zoom capability

Integrated

- Operators can focus on moving material efficiently with a factory-installed 3D and guidance system designed for the machine – no more “bolt-on” components. The fully integrated package comes with stroke sensing hydraulic cylinders, a multiple global navigation satellite system (multi-GNSS) and an inertial measurement unit (IMU) sensor
- Advance job site flexibility with multi-band UHF/915SS radio
- Fast, reliable job site connectivity with 4G LTE connectivity

Intelligent

- Operators can focus on moving material efficiently and limiting over-excavation by semi-automatically tracing the target surface
- Excellent ease of operation and bucket positioning with intelligent facing compass, light bar and sound guidance
- Outstanding efficiency, productivity and ease of operation with bucket angle hold control



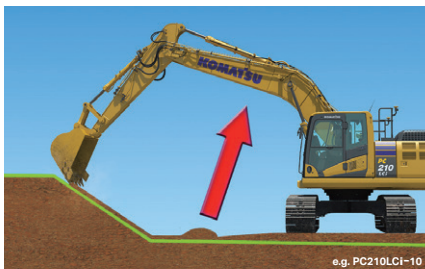

Photo may include optional equipment.

intelligent Machine Control

Over-excavation and damage to the design surface are minimized with Komatsu's unique sensor package, which includes stroke sensing hydraulic cylinders, an IMU sensor, and GNSS antennas. It utilizes 3D design data loaded in the control box to accurately check its position against the target. If the bucket hits the target surface, it is semi-automatically limited to minimize over-excavation.

If the operator turns off Auto mode, the machine can be operated with highly accurate, responsive machine guidance, with the machine only providing indication guidance.



Auto grade assist

With the auto grade assist function, the operator moves the arm, the boom adjusts the bucket height automatically, tracing the target surface and minimizing digging too deep. This allows the operator to perform rough digging without worrying about the design surface, and to perform fine digging by operating the arm lever only. The working range is extended by holding the lever to move the boom downward.

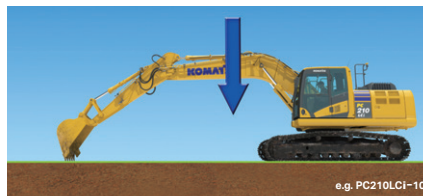

Auto stop control

During boom or bucket operation, the work equipment automatically stops when the bucket edge reaches the design surface, thus minimizing damage to the design surface.



Minimum distance control

The intelligent Machine Control excavator controls the bucket by automatically selecting the point on the bucket closest to the target surface. Should the machine not be facing a sloped surface at a right angle, it will still follow the target surface and minimize digging below it.

intelligent Machine Control (iMC)

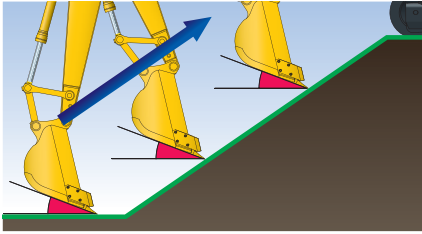

Bucket angle hold control

Operator sets desired bucket angle and the system automatically maintains bucket angle throughout the grading pass. Angle hold control increases ease of operation and improves final grading accuracy.

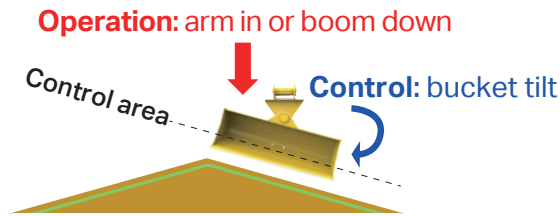

Auto tilt control

Automatically tilts bucket to design surface and returns it to horizontal to unload. Using auto tilt control with the existing minimum distance control and auto grade assist makes complex grading quicker and easier.

Improved construction efficiency

Staking, survey and final inspection (which is usually done manually), can be reduced with the intelligent Machine Control excavator by setting 3D design data on the control box. Also, use of the facing angle compass can minimize leveling work for the surface on which the machine sits. Even if the machine is inclined while working, the facing angle compass allows the operator to ensure that the machine is facing perpendicular to the target surface. The intelligent Machine Control technology allows the operator to improve work efficiency (i.e. shorter construction time) while minimizing over-excavating the target surface from rough digging to finish grading.

Comparison of construction time based on in-house test of excavation and grading slope surface*

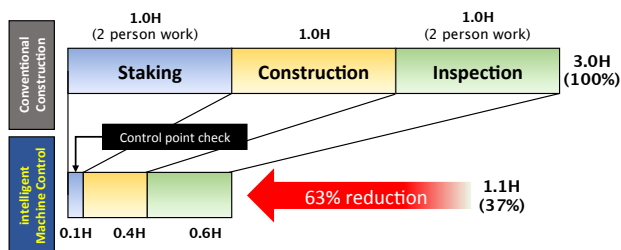

* When used by a qualified iMC operator, the Komatsu intelligent Machine Control system increases construction efficiency.
 * The above data does not include design time or working data creation time.
 The above data is based on in-house construction tests, performed by Komatsu, whose conditions may differ from actual construction.

Improved work accuracy

The bucket edge/tip position is instantly displayed on the control box, eliminating the wait time for display on the monitor during construction. The large and easy-to-view control box displays information clearly, aiding in highly accurate work. With manual operation and conventional machine guidance, finish grade quality and excavating accurately depends heavily on the skill of the operator. With the intelligent Machine Control excavator, the bucket is automatically limited to follow the target grade without over-excavating.

Relationship between finished surface and allowable value

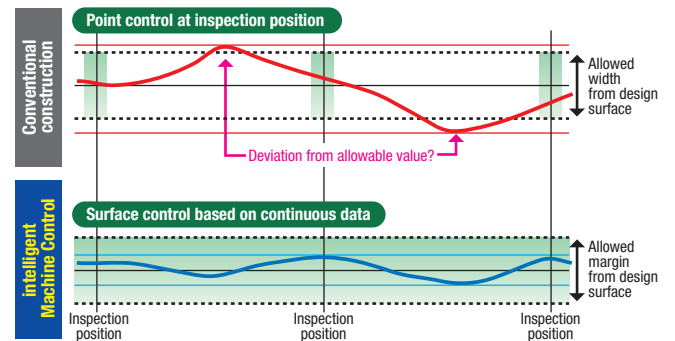

As-built surface mapping

Operator can display and check the as-built status and find where to cut and fill.

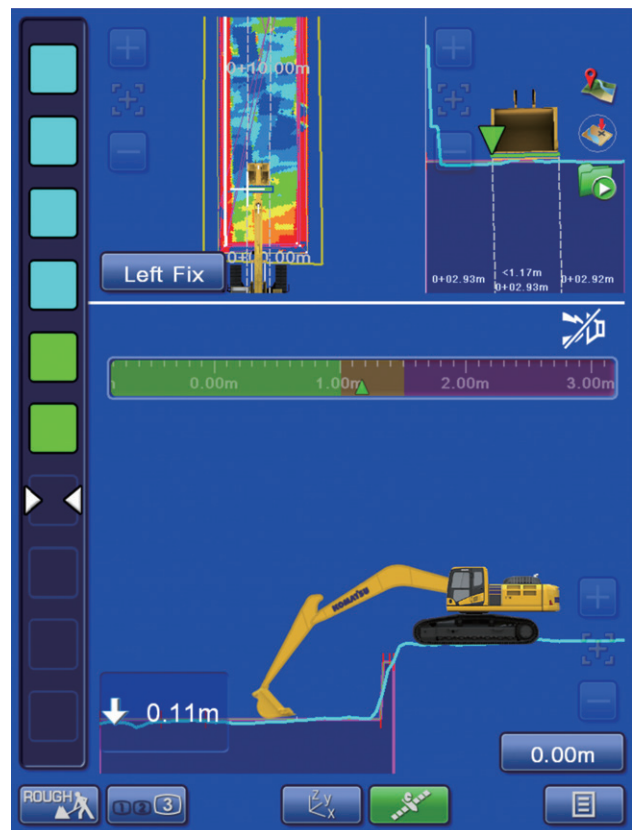

Control box

The monitor of the Komatsu intelligent Machine Control (control box) uses a compact 10.4-in (26.4-cm) screen for visibility and ease of use. The simple screen layout displays the necessary information in an easily understood fashion. Touch screen icon interface instead of multi-step menu simplifies operation.

Facing angle compass
Light bar

Auto/Manual switch

Bucket edge position selection button
Used to select the bucket edge position (left/middle/right/minimum distance) to determine the distance from the design surface

Pop-up map button
Displays a wide-area map

Edge position recording button

Sound guidance On/Off

Distance from design surface

Bucket edge position check button

GNSS signal reception status check button
Used to check signal reception from the GNSS

Mode selection button
Driving, rough digging, and fine digging modes

Design surface offset
The design surface can be offset in the vertical direction

Screen selection button
Use to change the screen layout

Main menu button
For various settings

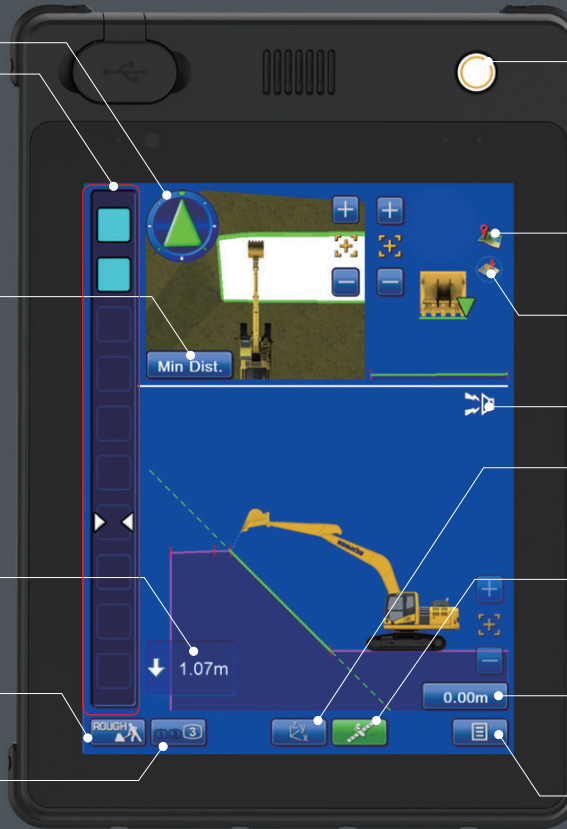

Preset elevation offset quick button

Pre-determined offsets can be stored in the monitor to allow an operator to easily switch between preset grades.

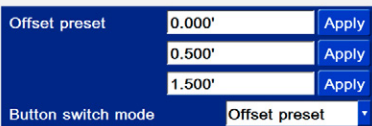

Quick bucket swap button

Allows users to quickly swap between various buckets without having to enter main menu. This lessens the time a user takes to change out a bucket on the monitor.



Machine navigation

Facing angle compass

The orientation and color of the facing angle compass's arrow shows the operator the facing angle of the bucket edge relative to the target surface. This allows the bucket edge to be accurately positioned square with the target surface, which is useful when finishing slopes.



Enhanced operability of the machine control

Semi-auto/manual mode switching and design surface offset function can be operated with switches on the control levers.



intelligent Machine Control (iMC)

Factory-installed Komatsu intelligent Machine Control components

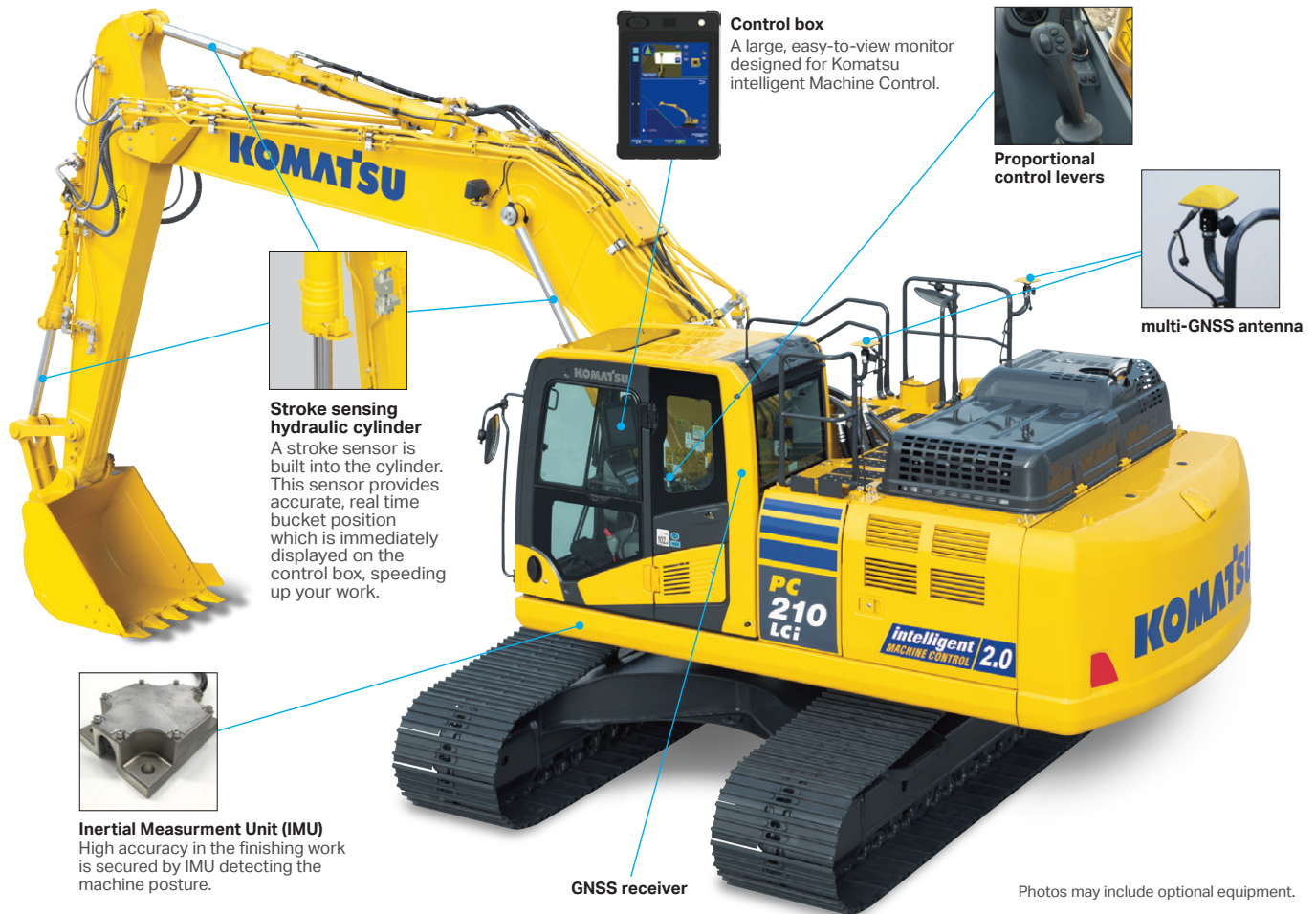

Control box
A large, easy-to-view monitor designed for Komatsu intelligent Machine Control.



Proportional control levers



multi-GNSS antenna

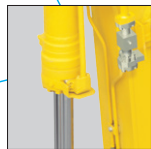

Stroke sensing hydraulic cylinder
A stroke sensor is built into the cylinder. This sensor provides accurate, real time bucket position which is immediately displayed on the control box, speeding up your work.

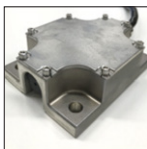

Inertial Measurement Unit (IMU)
High accuracy in the finishing work is secured by IMU detecting the machine posture.

GNSS receiver

Photos may include optional equipment.

SMARTCONSTRUCTION Remote

Customers can quickly send design files to intelligent machines and provide support to operators

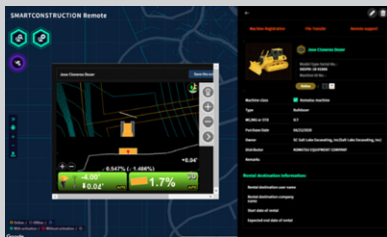

Users can log in to Smart Construction Remote, locate machines by job site to upload or download design files at any time.

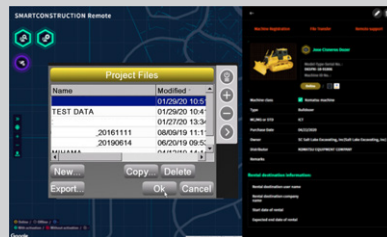

View the machine monitor to troubleshoot or add new files in the machine without the time requirements of traditional methods.



Capable of connecting to mixed fleet customers.



View or navigate machine monitor live with operator.

Working smarter in every way

Benefits of iMC 2.0



Save money

Frees GPS dozer from need to achieve final grade so it can work elsewhere on the site.



Save time

Reduce staking, grading and inspection with 3D design data and semi-automatic grading.

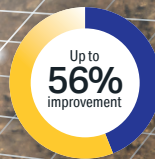

Less time grade checking

Monitor performance and stay on grade from the cab: operators spend time working, not grade checking.

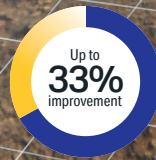

Improve accuracy

Continuously monitor grade and semi-automatics to dig precisely to grade.

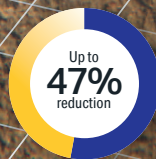

Reduce base aggregate

Greatly reduce over-digging and the amount of costly base aggregate needed for applications like utilities.

**All savings, improvements, and reductions are compared to traditional grading methods.*

Performance features

High rigidity work equipment

Designed for long-term durability and reliability, with booms and arms constructed with thick plates of high tensile strength steel. In addition, these structures are designed with large cross-sectional areas and large one-piece castings in the boom foot, the boom tip and the arm tip. A standard HD book design provides increased strength and reliability.

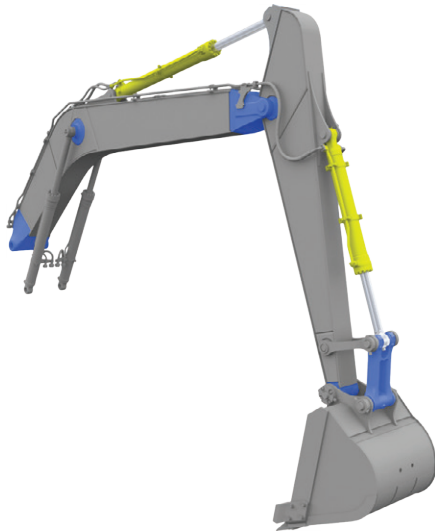

Working mode selection

The PC290LC/LCi-11 excavator is equipped with six working modes (P, E, L, B, ATT/P and ATT/E). Each mode is designed to match engine speed, pump flow, and system pressure to the application. The PC290LC/LCi-11 features an attachment mode (ATT/E) that allows operators to run attachments while in Economy mode.

Working mode	Application	Advantage
P	Power mode	<ul style="list-style-type: none"> • Maximum production/power • Fast cycle times
E	Economy mode	<ul style="list-style-type: none"> • Good cycle times • Better fuel economy
L	Lifting mode	<ul style="list-style-type: none"> • Increases hydraulic pressure
B	Breaker mode	<ul style="list-style-type: none"> • Optimum engine rpm, hydraulic flow
ATT/P	Attachment Power mode	<ul style="list-style-type: none"> • Optimum engine rpm, hydraulic flow, 2-way • Power mode
ATT/E	Attachment Economy mode	<ul style="list-style-type: none"> • Optimum engine rpm, hydraulic flow, 2-way • Economy mode

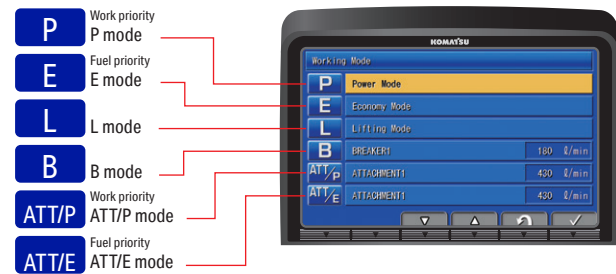

Increased work efficiency

Functional digging force can be increased with use of the one-touch Power Max. function (up to 8.5 seconds of operation).

Maximum arm crowd force (ISO)

12.6 t (124 kN) 13.6 t (133 kN) **7% UP**
(with Power Max.)

Maximum bucket digging force (ISO)

12.6 t (124 kN) 13.6 t (133 kN) **7% UP**
(with Power Max.)

Measured with Power Max. function, 126 in (3,200 mm) arm and ISO rating

Komatsu-integrated attachment control (optional)

Factory-integrated auxiliary hydraulic attachment control with programmable pressure and flow settings for up to 15 different tools. Settings can be easily changed from the machine monitor optimizing attachment control and performance. Proportional joysticks help expand versatility by giving the operator precise hydraulic attachment control.

*Not available on PC210LC-11



+1 Attachment piping (optional)

Factory-engineered auxiliary attachment circuit piping is designed and sized to work efficiently with the excavator main hydraulic system. Constructed of large diameter steel tubing with four bolt flange connections and robust mounting points, the auxiliary hydraulic piping is designed for durable, reliable use.

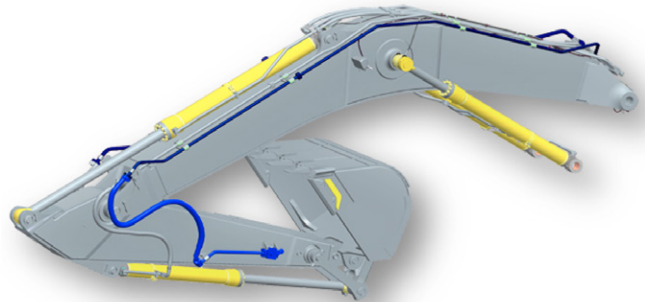

Komatsu innovative engine technology

Latest tier 4 final engine

The Komatsu SAA6D107E-3 engine is EPA Tier 4 Final emissions certified and provides exceptional performance and efficiency. Based on Komatsu proprietary technologies developed over many years, this new diesel engine reduces nitrogenoxides (NOx) by more than 80% when compared to Tier 4 interim levels. Through the in-house development and production of engines, electronics, and hydraulic components, Komatsu has achieved great advancements in technology, providing high levels of performance and efficiency in virtually all applications.

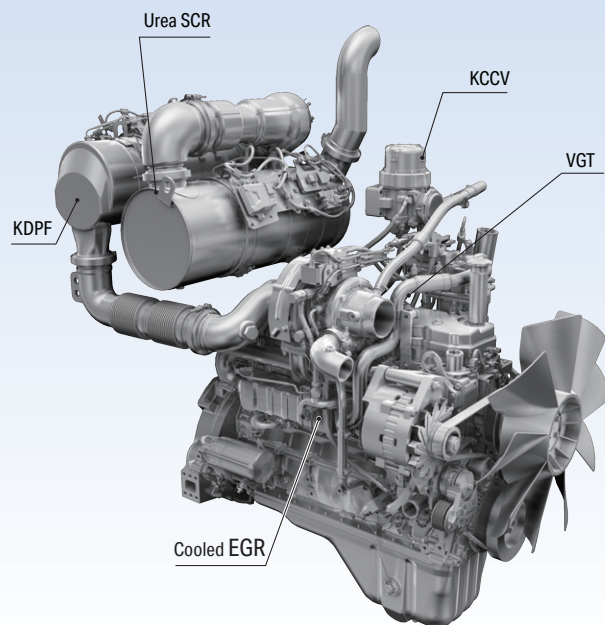

Working environment



Photo may include optional equipment. PC210LCi-11 shown.

Comfortable working space

Wide, spacious cabin

The cabin includes a seat with reclining backrests and a pull-up lever to easily adjust seat height and tilt angle. You can set the appropriate operational posture of armrest together with the console. Reclining the seat further enables you to place it into the fully flat state with the headrest attached.

Arm rest with simple height adjustment function

The addition of a knob and a plunger to the armrest permits the height of the armrest to be easily adjusted without the use of tools.



Low vibration with cab damper mounting

Automatic climate control

Pressurized cab

Auxiliary input jack

Connecting a regular audio device to the auxiliary jack allows the operator to hear the sound from the speakers installed in the cab.



Standard equipment

Sliding window glass (left side)



ISO/BH pattern change valve



Remote intermittent wiper with windshield washer



Easy-to-access AC controls



Opening and closing skylight



Magazine box and cup holder



Defroster (conforms to the ISO standard)



One-touch storable front window lower glass



General features

ROPS cab structure

ISO 12117-2

The machine is equipped with a ROPS cab that conforms to ISO 12117-2 for excavators as standard equipment. It also satisfies the requirements for level 1 Operator Protective Guard (OPG) and top guard (ISO 10262).



Rearview monitoring system

A rearview monitoring system display has a rearview camera image that is continuously displayed together with the gauges and important vehicle information. This enables the operator to carry out work while easily checking the surrounding area.



Low vibration with viscous cab mounts

The PC290LC-11 uses viscous mounts for the cab that incorporate a longer stroke and the addition of a spring. The cab damper mounting combined with a high rigidity deck reduces vibration at the operator's seat.

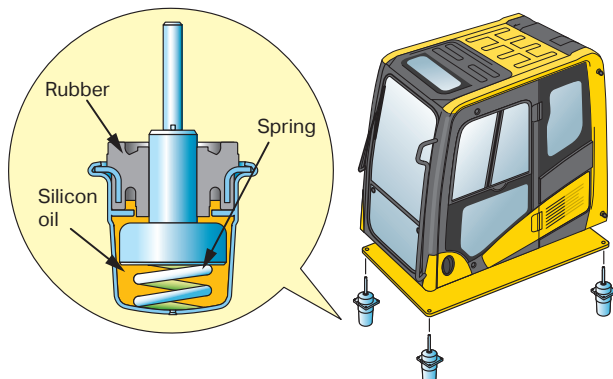

General features

Secondary engine shutdown switch at base of seat to shutdown the engine.



Left and right side handrails



Seat belt caution indicator



Lock lever

Seat belt retractable

Tempered and tinted glass

Large mirrors

Slip-resistant plates

Thermal and fan guards

Pump/engine room partition

Travel alarm

Large cab entrance step

Large, easy-open hood for engine and aftertreatment access

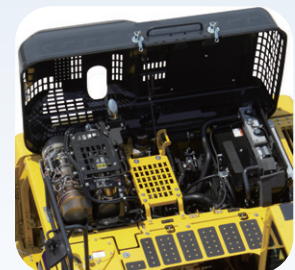

Maintenance features

Centralized engine check points

Locations of the engine oil check and filters are integrated into one side to allow easy maintenance and service.

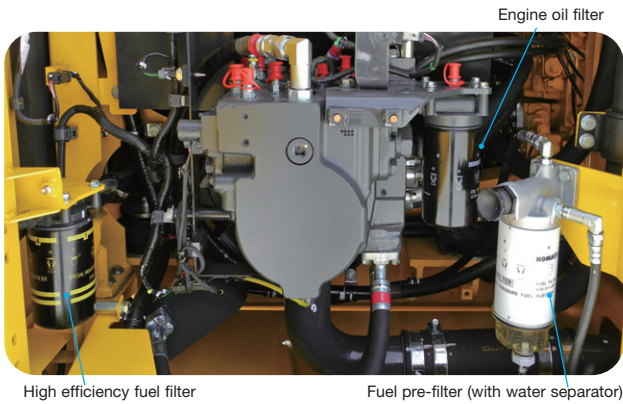

Tie off points standard (ISO 14567)

When working in elevated positions on the boom and track frame tie off points provide anchors for technician harness lanyards.



Easy-to-access air conditioner filter

Washable cab floor mat

Sloping track frame

Utility space

Easy cleaning of cooling unit

Fuel pre-filter with water separator

High efficiency primary fuel filter

Easy access to engine oil filter, engine oil, drain valve, fuel drain valve and water separator drain valve



Long-life oils, filters

High-performance filters are used in the hydraulic circuit and engine. By increasing the oil and filter replacement intervals, maintenance costs can be significantly reduced.

- Engine oil and Engine oil filter** every **500 hours**
- Hydraulic oil** every **5,000 hours**
- Hydraulic oil filter** every **1,000 hours**



Hydraulic oil filter (Ecology white element)

Large-capacity air cleaner

Comparable to that of larger machines, the larger air cleaner can extend air cleaner life during long-term operation and helps prevent early clogging, and resulting power loss. A radial seal design improves reliability.

Diesel exhaust fluid (DEF) tank

A large tank volume extends operating time before refilling and is installed on the right front platform for easy access. DEF tank and pump are separated for improved service access.

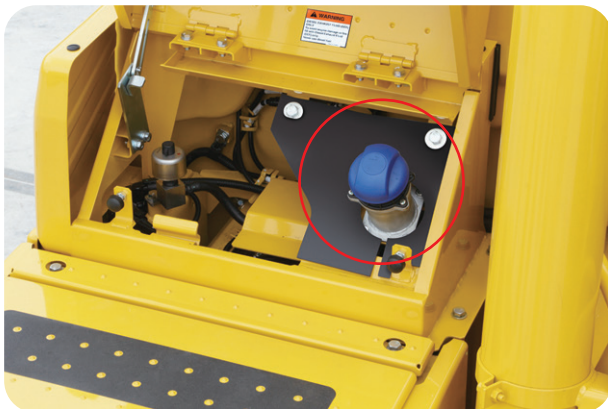

Maintenance information

"Maintenance time caution lamp" display

When the remaining time to maintenance becomes less than 30 hours*, a maintenance time monitor appears. Pressing the F6 key switches the monitor to the maintenance screen.

* The setting can be changed within the range between 10 and 200 hours.



Maintenance screen

Manual stationary regeneration

Under most conditions, active regeneration will occur automatically with no effect on machine operation. In case the operator needs to disable active regeneration or initiate a manual stationary regeneration, this can be easily accomplished through the monitor panel. A soot level indicator is displayed to show how much soot is trapped in the KDPF.

Soot level indicator



Aftertreatment device regeneration screen

Supports the DEF level and refill timing

The DEF level gauge is displayed continuously on the right side of the monitor screen. In addition, when DEF level is low, DEF low-level guidance messages appear in pop-up displays to inform the operator in real time.



DEF level gauge



DEF low-level guidance

DT-type connectors

Sealed DT-type electrical connectors provide high reliability, water and dust resistance.

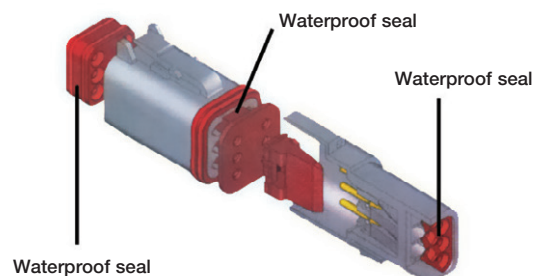

Komatsu parts and service support

Komatsu Care

*The PC290LC/LCi-11 comes standard with complimentary factory-scheduled maintenance for the first three years or 2,000 hours, whichever occurs first.

Planned maintenance intervals at:

500/1,000/1,500/2,000-hour intervals. (250-hr. initial interval for some products) complimentary maintenance interval includes: replacement of oils and fluid filters with genuine Komatsu parts, 50-point inspection, Komatsu oil and wear analysis sampling (KOWA)/travel and mileage (distance set by distributor; additional charges may apply)

Benefits of using Komatsu

- Assurance of proper maintenance with OEM parts and service
- Increased uptime and efficiency
- Factory-certified technicians performing work
- Cost of ownership savings
- Transferable upon resale

Complimentary SCR system maintenance

The PC290LC/LCi-11 also includes two factory-suggested services of the selective catalytic reduction (SCR) diesel exhaust fluid (DEF) system during the the first five years or 9,000 hours, whichever occurs first – including: factory-suggested DEF tank flush and strainer cleaning at 4,500 hours and 9,000 hours.

Complimentary KDPF exchange

The PC290LC/LCi-11 comes standard with two complimentary KDPF exchange units for the first five years or 9,000 hours, whichever occurs first. Complimentary KDPF exchange units are provided at: The suggested KDPF exchange units service intervals of 4,500 hours and 9,000 hours during the first five years or 9,000 hours, whichever occurs first. End user must have authorized Komatsu distributor perform the removal and installation of the KDPF.



Komatsu Oil and Wear Analysis (KOWA)

- KOWA detects fuel dilution, coolant leaks and measures wear metals
- Proactively maintain your equipment
- Maximize availability and performance
- Can identify potential problems before they lead to major repairs
- Reduce life cycle cost by extending component life

Interval PM	500	1,000	1,500	2,000
KOWA sampling — (engine, hydraulics, L and R swing machinery, L and R final drives)	•	•	•	•
Lubricate machine	•	•	•	•
Lubricate swing circle	•	•	•	•
Check swing pinion grease level and add, when necessary	•	•	•	•
Change engine oil	•	•	•	•
Replace engine oil filter	•	•	•	•
Replace fuel pre-filter	•	•	•	•
Replace AC fresh and recirc air filters	•	•	•	•
Clean air cleaner element	•	•	•	•
Drain sediment from fuel tank	•	•	•	•
Complete 50-point inspection form; leave pink copy with customer or in cab	•	•	•	•
Reset monitor panel maintenance counter for appropriate items	•	•	•	•
Replace hydraulic tank breather element		•		
Replace DEF tank breather		•		
Check damper case oil level, add when necessary		•		
Replace fuel main filter		•		
Replace hydraulic oil filter element		•		
Change swing machinery oil		•		
Change final drive oil				•
Clean hydraulic tank strainer				•
Replace DEF filter				•
Replace KCCV filter element				•
Factory-trained technician labor	•	•	•	•
2 KDPF exchanges suggested at 4,500 and 9,000 hours.				
2 SCR system maintenance services suggested at 4,500 and 9,000 hours.				



Komatsu Care — Extended coverage

- Extended coverage can provide peace of mind by protecting customers from unplanned expenses that affect cash flow
- Purchasing extended coverage locks-in the cost of covered parts and labor for the coverage period and helps turn these into fixed costs

Komatsu parts support

- 24/7/365 to fulfill your parts needs
- Nine parts distribution centers strategically located across the United States and Canada
- Distributor network of more than 300 locations across United States and Canada to serve you
- Online part ordering through Komatsu eParts
- Remanufactured components with same-as-new warranties at a significant cost reduction

*Certain exclusions and limitations apply. Refer to the customer certificate for complete program details and eligibility. Komatsu® and Komatsu Care® are registered trademarks of Komatsu Ltd. Copyright 2022 Komatsu America Corp.

Komatsu equipment monitoring

✓ What

- Komtrax is Komatsu’s remote equipment monitoring and management system
- Komtrax continuously monitors and records machine health and operational data
- Information such as fuel consumption, utilization, and a detailed history lowering owning and operating cost

✓ Who

- Komtrax is standard equipment on all Komatsu construction products and operating cost

✓ When

- Know when your machines are running or idling and make decisions that will improve your fleet utilization
- Detailed movement records ensure you know when and where your equipment is moved
- Up to date records allow you to know when maintenance is due and help you plan for future maintenance needs

✓ Where

- Komtrax data can be accessed virtually anywhere through your computer, the web or your smart phone
- Automatic alerts keep fleet managers up to date on the latest machine notifications and operating cost

✓ Why

- Knowledge is power - make informed decisions to manage your fleet better
- Knowing your idle time and fuel consumption will help maximize your machine efficiency
- Take control of your equipment - any time, anywhere

**Get the whole story
with Komtrax**

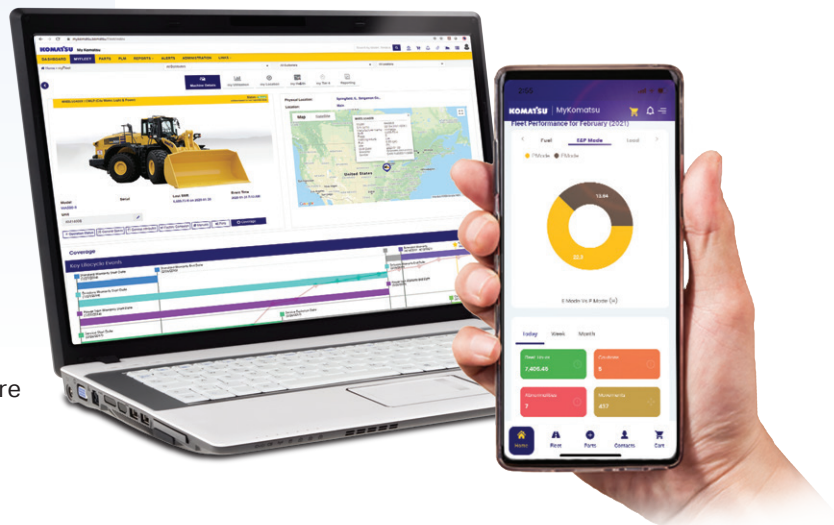

KOMTRAX®

For construction and compact equipment.

KOMTRAX Plus®

For production and mining class machines.

General specification

Engine*

Model	Komatsu SAA6D107E-3*		
Type	Water-cooled, 4-cycle, direct injection		
Aspiration	Komatsu variable geometry turbocharged, aftercooled, cooled EGR		
Number of cylinders	6		
Bore x stroke	107 mm x 124 mm 4.21" x 4.88"		
Piston displacement	6.69 L 408 in ³		
Horsepower			
SAE J1995	Gross	159 kW	213 HP
ISO 9249 / SAE J1349	Net	147 kW	196 HP
	Rated rpm	2,050	
Fan drive method for radiator cooling	Mechanical		
Governor	All-speed control, electronic		

*EPA Tier 4 Final emissions certified.

Hydraulics

Type	HydrauMind (Hydraulic Mechanical Intelligence) system, closed-center system with load sensing valves and pressure compensated valves		
Number of selectable working modes	6		
Main pump			
Type	Variable displacement piston type		
Pumps for	Boom, arm, bucket, swing, and travel circuits		
Maximum flow	479 L/min	126.5 gal/min	
Supply for control circuit	Self-reducing valve		
Hydraulic motors			
Travel	2 x axial piston motors with parking brake		
Swing	1 x axial piston motor with swing holding brake		
Relief valve setting			
Implement circuits	37.3 MPa	380 kg/cm ²	5,400 psi
Travel circuit	37.3 MPa	380 kg/cm ²	5,400 psi
Swing circuit	28.9 MPa	295 kg/cm ²	4,190 psi
Pilot circuit	3.2 MPa	33 kg/cm ²	470 psi
Hydraulic cylinders (Number of cylinders – bore x stroke x rod diameter)			
Boom	2-140 mm x 1300 mm x 100 mm	5.5" x 51.2" x 3.9"	
Arm	1-150 mm x 1635 mm x 110 mm	5.9" x 64.3" x 4.3"	
Bucket	1-140 mm x 1009 mm x 100 mm	5.5" x 39.7" x 3.9"	

Drives and brakes

Steering control	Two levers with pedals		
Drive method	Hydrostatic		
Maximum drawbar pull	249 kN	25,400 kg	56,000 lbs.
Gradeability	70%, 35"		
Maximum travel speed			
	High	5.5 km/h	3.4 mph
	(Auto-shift) Mid	4.1 km/h	2.5 mph
	(Auto-shift) Low	3.0 km/h	1.9 mph
Service brake	Hydraulic lock		
Parking brake	Mechanical disc brake		

Swing system

Drive method	Hydrostatic
Swing reduction	Planetary gear
Swing circle lubrication	Grease-bathed
Service brake	Hydraulic lock
Holding brake/Swing lock	Mechanical disc brake
Swing speed	10.5 rpm
Swing torque	8,889 kg·m 64,292 ft. lbs.

Undercarriage

Center frame	X-frame
Track frame	Box-section
Seal of track	Sealed track
Track adjuster	Hydraulic
Number of shoes (each side)	48
Number of carrier rollers (each side)	2
Number of track rollers (each side)	8

Coolant and lubricant capacity (refilling)

Fuel tank	400 L	105.7 U.S. gal
Coolant	36 L	9.5 U.S. gal
Engine	23.1 L	6.1 U.S. gal
Final drive, each side	8.0 L	2.1 U.S. gal
Swing drive	7.2 L	1.9 U.S. gal
Hydraulic tank	132 L	34.9 U.S. gal
Hydraulic system	253 L	66.8 U.S. gal
DEF tank	23.1 L	6.1 U.S. gal

Sound performance

Exterior – ISO 6395	104 dB(A)
Operator – ISO 6396	70 dB(A)

Operating weight (approximate)*

Operating weight includes 6,150 mm 20'2" one-piece boom, 3,200 mm 10'6" arm, SAE heaped 1.63 m³ 2.13 yd³ bucket, rated capacity of lubricants, coolant, full fuel tank, operator, and standard equipment.

Triple-grouser shoes	Operating weight	Ground pressure ISO 16754
700 mm 28"	32,070 kg 70,702 lbs.	0.53 kg/cm ² 7.48 psi
800 mm 31.5"	32,450 kg 71,540 lbs.	0.46 kg/cm ² 6.63 psi
850 mm 33.5"	32,700 kg 72,091 lbs.	0.44 kg/cm ² 6.28 psi

*See equipment page for option availability.

Component weights

Arm including bucket cylinder and linkage		
3,200 mm 10'6" arm assembly	1,432 kg	3,157 lbs.
3,500 mm 11'6" arm assembly	1,504 kg	3,316 lbs.
One piece boom including arm cylinder		
6,150 mm 20'2" boom assembly	2,448 kg	5,397 lbs.
Boom cylinders x 2	231 kg	509 lbs.
Counterweight	5,200 kg	11,464 lbs.
1.63 m ³ 2.13 yd ³ bucket - 54" width	1,168 kg	2,576 lbs.

Dimensions

Arm Length	3,200 mm	10'6"	3,500 mm	11'6"
A Overall length	10,265 mm	33'8"	10,275 mm	33'8"
B Length on ground (transport)	5,770 mm	18'11"	5,495 mm	18'0"
C Overall height (to top of boom)*	3,295 mm	10'10"	3,375 mm	11'0"
D Overall width	3,390 mm	11'1"		
E Overall height (to top of cab)*	3,180 mm	10'5"		
F Overall height (to top of handrail)*	3,275 mm	10'9"		
G Overall height (to top of GNSS antenna)*	3,345 mm	11'0"		
H Ground clearance, counterweight	1,215 mm	4' 0"		
I Ground clearance, minimum	495 mm	1'7"		
J Tail swing radius	3,020 mm	9'11"		
K Track length on ground	4,030 mm	13'3"		
L Track length	4,955 mm	16'3"		
M Track gauge	2,590 mm	8'6"		
N Width of crawler	700 mm 28" shoe	3,290 mm	10'7"	
	800 mm 31.5" shoe	3,390 mm	11'1"	
	850 mm 33.5" shoe	3,440 mm	11'3"	
O Shoe width	800 mm	31.5"		
P Grouser height	36 mm	1.4"		
Q Machine cab height	2,380 mm	7'10"		
R Machine height to top of engine cover	2,895 mm	9'6"		
S Machine upper width	2,850 mm	9'4"		
T Distance, swing center to rear end	2,985 mm	9'10"		

*Including grouser height

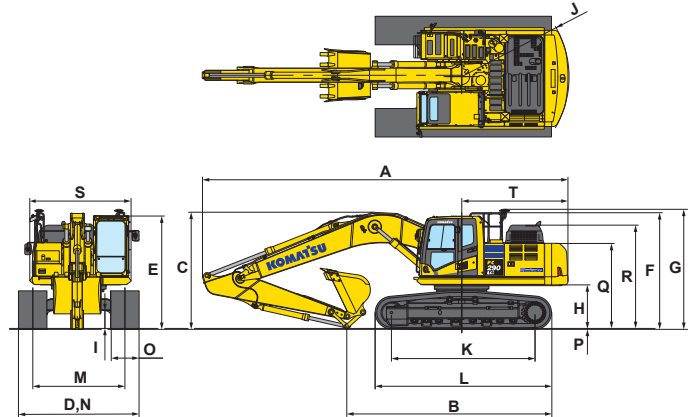

Backhoe bucket, arm and boom combination

Bucket type	Capacity		Bucket Width		Weight		6.15 m (20'2") Boom	
							3.2 m (10'6")	3.5 m (11'6")
Komatsu TL	0.58 m ³	0.76 yd ³	610 mm	24"	717 kg	1,571 lbs.	●	●
	0.78 m ³	1.02 yd ³	762 mm	30"	837 kg	1,846 lbs.	●	●
	0.99 m ³	1.29 yd ³	914 mm	36"	938 kg	2,067 lbs.	●	●
	1.20 m ³	1.57 yd ³	1,067 mm	42"	1,018 kg	2,245 lbs.	●	●
	1.41 m ³	1.85 yd ³	1,219 mm	48"	1,090 kg	2,404 lbs.	○	○
Komatsu HP	0.58 m ³	0.76 yd ³	610 mm	24"	717 kg	1,581 lbs.	●	●
	0.78 m ³	1.02 yd ³	762 mm	30"	929 kg	2,049 lbs.	●	●
	0.99 m ³	1.29 yd ³	914 mm	36"	1,051 kg	2,317 lbs.	●	●
	1.20 m ³	1.57 yd ³	1,067 mm	42"	1,151 kg	2,538 lbs.	●	●
	1.41 m ³	1.85 yd ³	1,219 mm	48"	1,273 kg	2,807 lbs.	○	○
Komatsu HPS	0.58 m ³	0.76 yd ³	610 mm	24"	848 kg	1,871 lbs.	●	●
	0.78 m ³	1.02 yd ³	762 mm	30"	990 kg	2,184 lbs.	●	●
	0.99 m ³	1.29 yd ³	914 mm	36"	1,125 kg	2,481 lbs.	●	●
	1.20 m ³	1.57 yd ³	1,067 mm	42"	1,239 kg	2,731 lbs.	●	●
	1.41 m ³	1.85 yd ³	1,219 mm	48"	1,338 kg	2,950 lbs.	○	○
Komatsu HPX	0.58 m ³	0.76 yd ³	610 mm	24"	951 kg	2,097 lbs.	●	●
	0.78 m ³	1.02 yd ³	762 mm	30"	1,092 kg	2,408 lbs.	●	●
	0.99 m ³	1.29 yd ³	914 mm	36"	1,233 kg	2,719 lbs.	●	●
	1.20 m ³	1.57 yd ³	1,067 mm	42"	1,354 kg	2,984 lbs.	●	○
	1.41 m ³	1.85 yd ³	1,219 mm	48"	1,475 kg	3,252 lbs.	○	○
	1.63 m ³	2.13 yd ³	1,372 mm	54"	1,585 kg	3,494 lbs.	□	⊙

For best semi-automatic machine control performance, observe maximum attachment weights:

- 2,100 kg 4,629 lbs. maximum for 3,200 mm 10'6" standard arm assembly
- 2,060 kg 4,541 lbs. maximum for 3,500 mm 11'6" standard arm assembly

Exceeding recommended attachment weights may negatively impact performance and accuracy of semi-automatic function.

- - Used with material weights up to 3,500 lbs./yd³ - Quarry/rock/high abrasion applications
- - Used with material weights up to 2,500 lbs./yd³ - General construction
- - Used with material weights up to 3,000 lbs./yd³ - Tough digging applications

- - Used with material weights up to 2,000 lbs./yd³ - Light materials applications
- X - Not useable

General specification

Working range

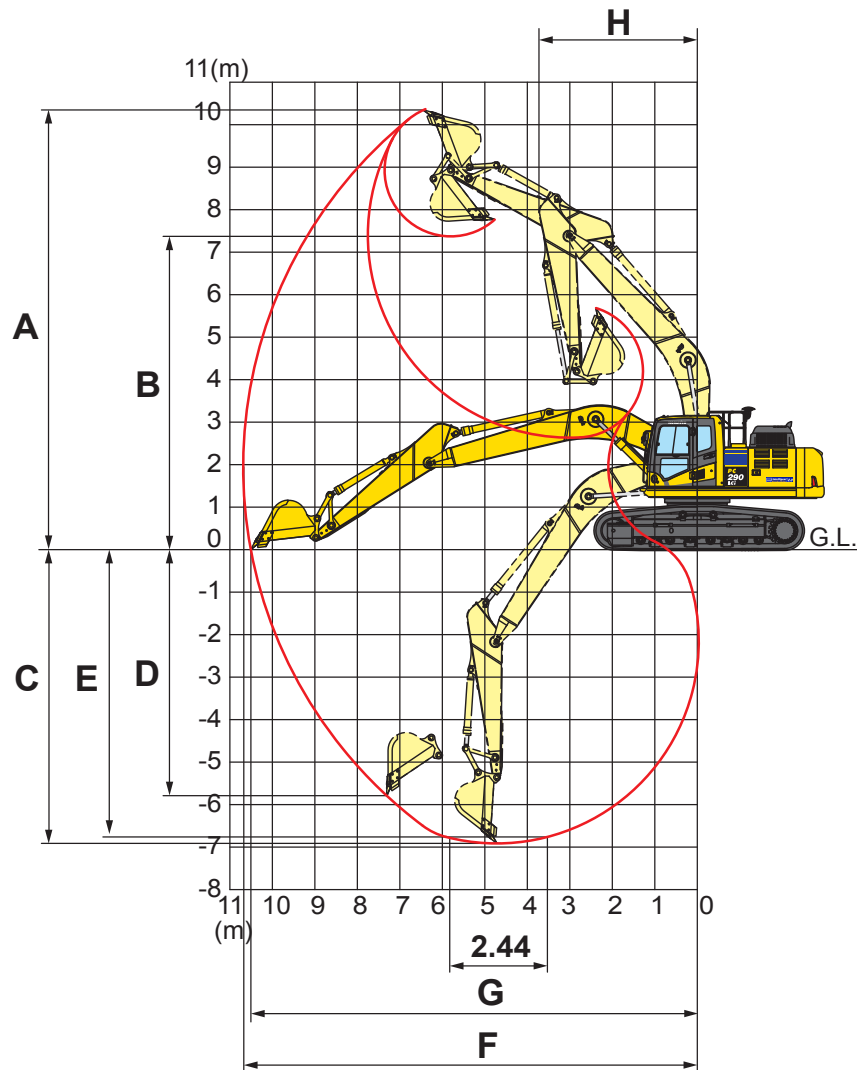

	Arm length	3,200 mm	10'6"	3,500 mm	11'6"
A	Max. digging height	10,300 mm	33'10"	10,335 mm	33'11"
B	Max. dumping height	7,375 mm	24'2"	7,440 mm	24'5"
C	Max. digging depth	6,820 mm	22'5"	7,120 mm	23'4"
D	Max. vertical wall digging depth	5,740 mm	18'10"	5,850 mm	19'2"
E	Max. digging depth for 8' level bottom	6,750 mm	22'2"	7,070 mm	23'2"
F	Max. digging reach	10,710 mm	35'2"	10,890 mm	35'8"
G	Max. digging reach at ground level	10,450 mm	34'3"	10,715 mm	35'2"
H	Min. swing radius	3,680 mm	12'1"	3,740 mm	12'3"
SAE rating	Bucket digging force at power max.	176 kN 17,900 kg / 39,463 lbs.		176 kN 17,900 kg / 39,463 lbs.	
	Arm crowd force at power max.	129 kN 13,100 kg / 28,881 lbs.		121 kN 12,400 kg / 27,337 lbs.	
ISO rating	Bucket digging force at power max.	198 kN 20,200 kg / 44,533 lbs.		198 kN 20,200 kg / 44,533 lbs.	
	Arm crowd force at power max.	133 kN 13,600 kg / 29,983 lbs.		125 kN 12,800 kg / 28,219 lbs.	

Lifting capacity with lifting mode

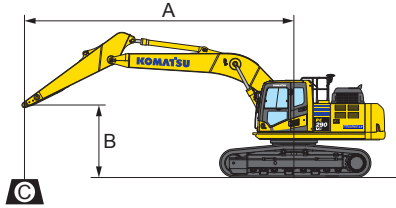

- A: Reach from swing center
- B: Bucket hook height
- C: Lifting capacity
- Cf: Rating over front
- Cs: Rating over side
- ⊗ Rating at maximum reach

- Conditions:**
- Boom length: 6,150 mm 20' 2"
 - Bucket: None
 - Lifting mode: On

Arm: 3,200 mm 10'6"		Bucket: None				Shoes: 800 mm 31.5" triple grouser				Unit: kg lbs.				
B	A	3.0 m 10'		4.6 m 15'		6.1 m 20'		7.6 m 25'		9.1 m 30'		MAX ⊗		
		Cf	Cs	Cf	Cs	Cf	Cs	Cf	Cs	Cf	Cs	⊗	Cf	Cs
7.6 m 25'												7.1 m 23'	* 4,700	* 4,700
6.1 m 20'						* 7,350	* 7,350	* 6,350	5,950			8.1 m 26'	* 4,500	* 4,500
4.6 m 15'				* 9,700	* 9,700	* 8,250	8,150	* 7,550	5,850			8.7 m 29'	* 4,500	* 4,500
3.0 m 10'				* 12,350	11,800	* 9,550	7,800	* 8,200	5,650			9.0 m 30'	* 4,650	4,450
1.5 m 5'				* 27,300	26,000	* 21,100	17,200	* 18,000	12,500				* 10,300	9,800
0 m 0'	* 7,300	* 7,300	* 15,850	10,700	* 11,600	7,200	8,500	5,350				9.1 m 29'	* 5,000	4,300
-1.5 m -5'	* 16,200	* 16,200	* 34,900	23,600	* 25,600	15,900	18,700	11,800				8.9 m 29'	* 11,000	9,500
-3.0 m -10'	* 12,550	* 12,550	* 15,850	10,550	11,600	7,100	8,400	5,300				8.4 m 28'	* 6,450	4,700
-4.6 m -15'	* 27,700	* 27,700	* 35,000	23,300	25,600	15,600	18,600	11,700				7.6 m 25'	* 14,200	10,400
	* 19,250	* 19,250	* 14,900	10,650	* 11,300	7,100						6.3 m 21'	* 8,200	5,400
	* 42,500	* 42,500	* 32,900	23,400	* 24,900	15,700							* 18,100	11,900
	* 17,100	* 17,100	* 12,600	10,850	* 9,250	7,300							* 8,800	7,000
	* 37,800	* 37,800	* 27,800	23,900	* 20,400	16,100							* 19,400	15,400

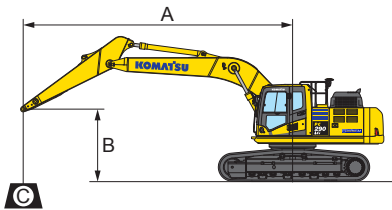

- A: Reach from swing center
- B: Bucket hook height
- C: Lifting capacity
- Cf: Rating over front
- Cs: Rating over side
- ⊗ Rating at maximum reach

- Conditions:**
- Boom length: 6,150 mm 20' 2"
 - Bucket: None
 - Lifting mode: On

Arm: 3,500 mm 11'6"		Bucket: None				Shoes: 800 mm 31.5" triple grouser				Unit: kg lbs.						
B	A	1.5 m 5'		3.0 m 10'		4.6 m 15'		6.1 m 20'		7.6 m 25'		9.1 m 30'		MAX ⊗		
		Cf	Cs	Cf	Cs	Cf	Cs	Cf	Cs	Cf	Cs	Cf	Cs	⊗	Cf	Cs
7.6 m 25'														7.4 m 24'	* 4,300	* 4,300
6.1 m 20'										* 6,300	60,00			8.3 m 27'	* 4,150	* 4,150
4.6 m 15'										* 13,900	13,200			8.9 m 29'	* 9,200	* 9,200
3.0 m 10'										* 7,900	* 7,900	* 7,250	5,850	9.3 m 30'	* 4,150	* 4,150
1.5 m 5'										* 17,400	* 17,400	* 16,000	12,900	9.3 m 31'	* 9,200	* 9,200
0 m 0'										* 11,750	* 11,750	* 9,200	7,800	9.3 m 30'	* 4,300	4,250
-1.5 m -5'										* 25,900	* 25,900	* 20,300	17,200	9.3 m 31'	* 9,500	9,400
-3.0 m -10'										* 14,200	11,100	* 10,500	7,450	9.3 m 31'	* 4,550	4,150
-4.6 m -15'										* 31,300	24,500	* 23,100	16,400	9.3 m 31'	* 10,100	9,100
										* 15,600	10,650	* 11,400	71,50	9.1 m 30'	* 5,050	4,200
										* 18,100	* 18,100	* 34,300	23,500	9.1 m 30'	* 11,100	9,300
	* 8,150	* 8,150	* 12,500	* 12,500	* 15,850	10,450	11,550	7,000	8,350	5,250				8.7 m 28'	* 5,850	4,450
	* 18,000	* 18,000	* 27,500	* 27,500	* 34,900	23,100	25,500	15,500	18,500	11,600				7.9 m 26'	* 12,900	9,900
	* 12,800	* 12,800	* 18,250	* 18,250	* 15,100	10,500	* 11,400	7,000	8,400	5,250				7.9 m 26'	* 7,350	5,050
	* 28,200	* 28,200	* 40,300	* 40,300	* 33,300	23,200	* 25,100	15,500	18,500	11,600				6.6 m 22'	* 16,300	11,200
															* 8,650	6,400
															* 19,100	14,200

*Asterisk indicates load is limited by hydraulic capacity rather than tipping. Ratings are based on ISO standard No. 10567. Rated load capacity does not exceed 87% of hydraulic lift capacity or 75% of tipping load. Total weight of bucket and/or installed attachments must be deducted from the capacities shown above. Lift capacity chart is based on machine located on a solid, level and uniform surface. Load ratings are at the arm bucket pin location, use of any attachment point in a different location to handle objects could affect excavator lift performance.

General specification

Lifting capacity with lifting mode

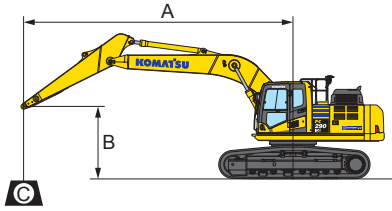

- A: Reach from swing center
- B: Bucket hook height
- C: Lifting capacity
- Cf: Rating over front
- Cs: Rating over side
- ☉ Rating at maximum reach

- Conditions:
- Boom length: 6,150 mm 20' 2"
 - Bucket: None
 - Lifting mode: On

Arm: 3,200 mm 10'6"		Bucket: None				Shoes: 700 mm 28" triple grouser				Unit: kg lbs.				
B	A	3.0 m 10'		4.6 m 15'		6.1 m 20'		7.6 m 25'		9.1 m 30'		MAX ☉		
		Cf	Cs	Cf	Cs	Cf	Cs	Cf	Cs	Cf	Cs	☉	Cf	Cs
7.6 m 25'												7.1 m 23'	* 4,700	* 4,700
													* 10,400	* 10,400
6.1 m 20'						* 7,350	* 7,350	* 6,350	5,900			8.1 m 26'	* 45,000	* 4,500
						* 16,200	* 16,200	* 14,000	13,000				* 10,000	* 10,000
4.6 m 15'				* 9,700	* 9,700	* 8,250	8,050	* 7,550	5,800			8.7 m 29'	* 4,500	* 4,500
				* 21,300	* 21,300	* 18,200	17,800	* 16,700	12,700				* 10,000	* 10,000
3.0 m 10'				* 12,350	11,650	* 9,550	7,700	* 8,200	5,600			9.0 m 30'	* 4,650	4,400
				* 27,300	25,700	* 21,100	17,000	* 18,000	12,400				* 10,300	9,700
1.5 m 5'				* 14,700	10,950	* 10,800	7,350	8,550	5,450			9.1 m 30'	* 5,000	4,250
				* 32,400	24,100	* 23,800	16,200	18,800	12,000				* 11,000	9,400
0 m 0'	* 7,300	* 7,300	* 15,850	10,550	11,600	7,100	8,400	5,300				8.9 m 29'	* 5,500	4,350
	* 16,200	* 16,200	* 34,900	23,300	25,600	15,700	18,500	11,700					* 12,200	9,600
-1.5 m -5'	* 12,550	* 12,550	* 15,850	10,450	11,500	7,000	8,300	5,250				8.4 m 28'	* 6,450	4,650
	* 27,700	* 27,700	* 35,000	23,000	25,300	15,400	18,300	11,500					* 14,200	10,200
-3.0 m -10'	* 19,250	* 19,250	* 14,900	10,500	* 11,300	7,000						7.6 m 25'	* 8,200	5,300
	* 42,500	* 42,500	* 32,900	23,200	* 24,900	15,500							* 18,100	11,700
-4.6 m -15'	* 17,100	* 17,100	* 12,600	10,750	* 9,250	7,200						6.3 m 21'	* 8,800	6,900
	* 37,800	* 37,800	* 27,800	23,700	* 20,400	15,900							* 19,400	15,300

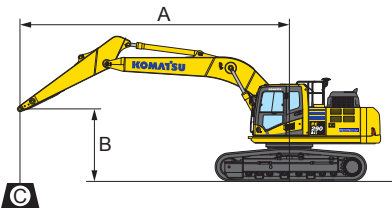

- A: Reach from swing center
- B: Bucket hook height
- C: Lifting capacity
- Cf: Rating over front
- Cs: Rating over side
- ☉ Rating at maximum reach

- Conditions:
- Boom length: 6,150 mm 20' 2"
 - Bucket: None
 - Lifting mode: On

Arm: 3,500 mm 11'6"		Bucket: None				Shoes: 700 mm 28" triple grouser				Unit: kg lbs.						
B	A	1.5 m 5'		3.0 m 10'		4.6 m 15'		6.1 m 20'		7.6 m 25'		9.1 m 30'		MAX ☉		
		Cf	Cs	Cf	Cs	Cf	Cs	Cf	Cs	Cf	Cs	Cf	Cs	☉	Cf	Cs
7.6 m 25'														7.4 m 24'	* 4,300	* 4,300
															* 9,500	* 9,500
6.1 m 20'										* 6,300	5,950			8.3 m 27'	* 4,150	* 4,150
										* 13,900	13,100				* 9,200	* 9,200
4.6 m 15'								* 7,900	* 7,900	* 7,250	5,800			8.9 m 29'	* 4,150	* 4,150
								* 17,400	* 17,400	* 16,000	12,800				* 9,200	* 9,200
3.0 m 10'						* 11,750	11,750	* 9,200	7,750	* 7,950	5,600	* 5,000	4,300	9.3 m 30'	* 4,300	4,200
						* 25,900	25,900	* 20,300	17,000	* 17,500	12,400	* 11,000	9,500		* 9,500	9,300
1.5 m 5'						* 14,200	10,950	* 10,500	7,350	8,550	5,400	* 5,750	4,200	9.3 m 31'	* 4,550	4,100
						* 31,300	24,200	* 23,100	16,200	18,800	12,000	* 12,700	9,300		* 10,100	9,000
0 m 0'				* 8,200	* 8,200	* 15,600	10,500	* 11,400	7,100	8,350	5,250			9.1 m 30'	* 5,050	4,150
				* 18,100	* 18,100	* 34,300	23,200	* 25,200	15,600	18,400	11,600				* 11,100	9,200
-1.5 m -5'	* 8,150	* 8,150	* 12,500	* 12,500	* 15,850	10,350	11,400	6,950	8,250	5,200				8.7 m 28'	* 5,850	4,400
	* 18,000	* 18,000	* 27,500	* 27,500	* 34,900	22,800	25,200	15,300	18,200	11,400					* 12,900	9,700
-3.0 m -10'	* 12,800	* 12,800	* 18,250	* 18,250	* 15,100	10,400	* 11,400	6,950	8,300	5,200				7.9 m 26'	* 7,350	5,000
	* 28,200	* 28,200	* 40,300	* 40,300	* 33,300	22,900	* 25,100	15,300	18,300	11,500					* 16,300	11,000
-4.6 m -15'			* 18,100	* 18,100	* 13,150	10,550	* 9,800	7,050						6.6 m 22'	* 8,650	6,350
			* 39,900	* 39,900	* 29,000	23,300	* 21,600	15,600							* 19,100	14,000

*Asterisk indicates load is limited by hydraulic capacity rather than tipping. Ratings are based on ISO standard No. 10567. Rated load capacity does not exceed 87% of hydraulic lift capacity or 75% of tipping load. Total weight of bucket and/or installed attachments must be deducted from the capacities shown above. Lift capacity chart is based on machine located on a solid, level and uniform surface. Load ratings are at the arm bucket pin location, use of any attachment point in a different location to handle objects could affect excavator lift performance.

Lifting capacity with lifting mode

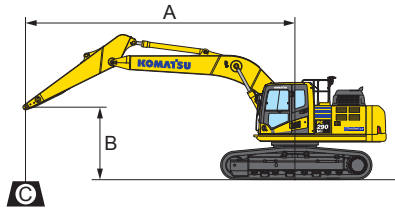

- A: Reach from swing center
- B: Bucket hook height
- C: Lifting capacity
- Cf: Rating over front
- Cs: Rating over side
- ⊗ Rating at maximum reach

- Conditions:
- Boom length: 6,150 mm 20' 2"
 - Bucket: None
 - Lifting mode: On

Arm: 3,200 mm 10'6"		Bucket: None						Shoes: 850 mm 33.5" triple grouser				Unit: kg lbs.		
B	A	3.0 m 10'		4.6 m 15'		6.1 m 20'		7.6 m 25'		9.1 m 30'		MAX ⊗		
		Cf	Cs	Cf	Cs	Cf	Cs	Cf	Cs	Cf	Cs	⊗	Cf	Cs
7.6 m 25'												7.1 m 23'	* 4,700	* 4,700
6.1 m 20'						* 7,350	* 7,350	* 6,350	5,950			8.1 m 26'	* 4,500	* 4,500
4.6 m 15'				* 9,700	* 9,700	* 8,250	8,200	* 7,550	5,850			8.7 m 29'	* 4,500	* 4,500
3.0 m 10'				* 12,350	11,850	* 95,50	7,850	* 8,200	5,700			9.0 m 30'	* 4,650	4,450
1.5 m 5'				* 27,300	26,100	* 21,100	17,300	* 18,000	12,600				* 10,300	9,800
0 m 0'	* 7,300	* 7,300	* 15,850	10,750	* 11,600	7,250	8,550	5,400				9.1 m 30'	* 5,000	4,350
-1.5 m -5'	* 16,200	* 16,200	* 34,900	23,700	* 25,600	16,000	18,800	11,900				8.9 m 29'	* 11,000	9,600
-3.0 m -10'	* 12,550	* 12,550	* 15,850	10,650	11,700	7,150	8,450	5,350				8.4 m 28'	* 5,500	4,400
-4.6 m -15'	* 27,700	* 27,700	* 35,000	23,400	25,800	15,700	18,700	11,700				8.4 m 28'	* 6,450	4,700
	* 19,250	* 19,250	* 14,900	10,700	* 11,300	7,150						7.6 m 25'	* 14,200	10,400
	* 42,500	* 42,500	* 32,900	23,600	* 24,900	15,700						7.6 m 25'	* 8,200	5,400
	* 17,100	* 17,100	* 12,600	10,900	* 9,250	7,300						6.3 m 21'	* 18,100	12,000
	* 37,800	* 37,800	* 27,800	24,100	* 20,400	16,200						6.3 m 21'	* 8,800	7,050
													* 19,400	15,500

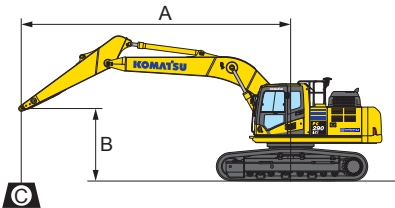

- A: Reach from swing center
- B: Bucket hook height
- C: Lifting capacity
- Cf: Rating over front
- Cs: Rating over side
- ⊗ Rating at maximum reach

- Conditions:
- Boom length: 6,150 mm 20' 2"
 - Bucket: None
 - Lifting mode: On

Arm: 3,500 mm 11'6"		Bucket: None						Shoes: 850 mm 33.5" triple grouser				Unit: kg lbs.									
B	A	1.5 m 5'		3.0 m 10'		4.6 m 15'		6.1 m 20'		7.6 m 25'		9.1 m 30'		MAX ⊗							
		Cf	Cs	Cf	Cs	Cf	Cs	Cf	Cs	Cf	Cs	Cf	Cs	⊗	Cf	Cs					
7.6 m 25'														7.4 m 24'	* 4,300	* 4,300					
6.1 m 20'										* 6,300	6,000			8.3 m 27'	* 9,500	* 9,500					
4.6 m 15'										* 7,900	* 7,900	* 7,250	5,900	8.9 m 29'	* 4,150	4,150					
3.0 m 10'										* 17,400	* 17,400	* 16,000	13,000	9.3 m 30'	* 9,200	9,200					
1.5 m 5'										* 11,750	11,750	* 9,200	7,850	* 5,000	4,350	9.3 m 30'	* 4,300	4,300			
0 m 0'										* 25,900	25,900	* 20,300	17,300	* 17,500	12,600	* 11,000	9,600	30'	* 9,500	9,500	
-1.5 m -5'										* 14,200	11,150	* 10,500	7,500	8,650	5,500	* 5,750	4,300	9.3 m 31'	* 4,550	4,150	
-3.0 m -10'										* 31,300	24,600	* 23,100	16,500	19,000	12,200	* 12,700	9,400	31'	* 10,100	9,200	
-4.6 m -15'										* 8,200	* 8,200	* 15,600	10,700	* 11,400	7,200	8,500	5,350	9.1 m 30'	* 5,050	4,250	
										* 18,100	* 18,100	* 34,300	23,600	* 25,200	15,900	18,800	11,800	30'	* 11,100	9,300	
	* 8,150	* 8,150	* 12,500	* 12,500	* 15,850	10,550	11,650	7,050	8,400	5,300				8.7 m 28'	* 5,850	4,500					
	* 18,000	* 18,000	* 27,500	* 27,500	* 34,900	23,200	25,700	15,600	18,600	11,600				8.7 m 28'	* 12,900	9,900					
	* 12,800	* 12,800	* 18,250	* 18,250	* 15,100	10,550	* 11,400	7,050	8,450	5,300				7.9 m 26'	* 7,350	5,100					
	* 28,200	* 28,200	* 40,300	* 40,300	* 33,300	23,300	* 25,100	15,600	18,600	11,700				26'	* 16,300	11,200					
	* 18,100	* 18,100	* 13,150	10,750	* 9,800	7,200								6.6 m 22'	* 8,650	6,450					
										* 39,900	* 39,900	* 29,000	23,700	* 21,600	15,900						

*Asterisk indicates load is limited by hydraulic capacity rather than tipping. Ratings are based on ISO standard No. 10567. Rated load capacity does not exceed 87% of hydraulic lift capacity or 75% of tipping load. Total weight of bucket and/or installed attachments must be deducted from the capacities shown above. Lift capacity chart is based on machine located on a solid, level and uniform surface. Load ratings are at the arm bucket pin location, use of any attachment point in a different location to handle objects could affect excavator lift performance.

Equipment

Cab	PC290LC	PC290LCi
ROPS cab (ISO12117-2)	●	●
High back air suspension seat, with heat	●	●
Operator Protective Guard (OPG) Level 1 top guard	●	●
Large LCD high resolution color monitor	●	●
Automatic climate control	●	●
Retractable seat belt (76mm width) with indicator	●	●
Two 12 V accessory outlets	●	●
Rearview mirrors, right hand and left hand side	●	●
Rearview monitoring system (1 camera)	●	●
Travel alarm	●	●
Proportional joystick control levers	○	●
Operator identification system	●	●
Hydraulic lock lever	●	●
Skylight	●	●
Sunvisor	○	○
Rainvisor	○	○
Working lights, two additional cab mounted	○	○
Straight travel pedal	□	□

Engine	PC290LC	PC290LCi
Komatsu SAA6D107E-3 Tier 4 Final	●	●
Dry type air cleaner, double element	●	●
Fuel pre-filter with water separator	●	●
Fuel high efficiency filter	●	●
Automatic engine warm up system	●	●
Programmable auto-idle shut down	●	●
Overheat prevention system	●	●
Turbocharger protection system	●	●

Hydraulic controls	PC290LC	PC290LCi
Pattern change control valve (ISO to BH control)	●	●
Working mode selection system (6 modes)	●	●
Dual pump, closed center load sensing system (CLSS)	●	●
Auto-deceleration system	●	●
Power max system	●	●
Boom and arm holding valves	●	●
Arm quick return valve	●	●
One-way/two-way flow hydraulic control unit Variable flow, return filter, and accumulator	○	-
One-way/two-way flow hydraulic control unit Variable pressure and flow, return filter, and accumulator	-	○

Technology	PC290LC	PC290LCi
Komtrax level 5.0	●	●
intelligent Machine Control	-	●
264 mm (10.4") IMC color monitor with USB	-	●
Multi-band UHF/915SS radio	-	●
Auto grade assist	-	●
Auto stop control	-	●
Minimum distance control	-	●
Bucket angle hold control	-	●
Provision for auto tilt control*	-	●
Komvision (4 camera system)	-	○□
IMU for auto-tilt control	-	□
In field design — 2D simple surface	-	●

Electrical system	PC290LC	PC290LCi
Batteries, large capacity (2 x 12 V)	●	●
Battery master disconnect switch with lockout tagout	●	●
Alternator (90 A, 24 V)	●	●
Starter motor (5.5 kW)	●	●
Secondary engine shut-off switch	●	●
Working lights (1 front RH side/1 boom LH side)	●	●

Booms and arms	PC290LC	PC290LCi
6,150 mm (20'2") boom assembly	●	●
6,150 mm (20'2") boom assembly with +1 attach piping	○	○
3,200 mm (10'6") arm assembly	●	●
3,200 mm (10'6") arm assembly with +1 attach piping	○	○
3,500 mm (11'6") arm assembly	○	○
3,500 mm (11'6") arm assembly with +1 attach piping	○	○
Boom foot, boom nose, and arm end steel castings	●	●

Undercarriage and work equipment	PC290LC	PC290LCi
800 mm (31.5") triple grouser track shoes	●	●
850 mm (33.5") triple grouser track shoes	○	○
700 mm (28") triple grouser track shoes	○	○
8 track/2 carrier rollers (each side)	●	●
Hydraulic track adjusters (each side)	●	●
Track guiding guards, center section (each side)	●	●
Track roller guards, full length (each side)	○	○
Counterweight, 5,200 kg (11,464 lb)	●	●
Counterweight, 5,500 kg (12,125 lb)**	○	-
Object handling H-link	●	●
Tie off points (ISO 14567) — work equipment and upper structure	●	●

Guards and covers	PC290LC	PC290LCi
Revolving frame deck guards	●	●
Revolving frame undercovers — standard	●	●
Track frame swivel guard	●	●
Pump/engine room partition	●	●
Turbocharger exhaust manifold cover	●	●
Dust net for radiator and hydraulic oil cooler	●	●
Slip-resistant foot plates	●	●
Tool-free access to engine and aftertreatment	●	●
Left and right side hand rails	●	●
Cab full front guard, OPG Level 1	○	○
Cab full front guard, OPG Level 2	○	○
Cab top guard, OPG Level 2	○	○
Revolving frame undercovers — heavy duty	○	○

Drive and brake system	PC290LC	PC290LCi
Three speed travel with auto shift	●	●
Double reduction type final drive	●	●
Triple labyrinth final drive seals	●	●

*IMU for auto-tilt control and one-way/two-way flow hydraulic control unit required for operation

**With revolving frame reinforcements, only available with super long fronts

For a complete list of available attachments, please contact your local Komatsu distributor.

Standard equipment	●
Optional equipment	○
Optional (field install)	□
Not applicable	-

Product designs, specifications and/or data in this document are provided for informational purposes only and are not warranties of any kind. Product designs and/or specifications may be changed at any time without notice. The only warranties that apply to sales of products and services are Komatsu's standard written warranties, which will be furnished upon request.

Komatsu and other trademarks and service marks used herein are the property of Komatsu Ltd., Komatsu America Corp., Komatsu Mining Corp., or one of their affiliates, or the respective owners or licensees.

KOMATSU

komatsu.com

