

# KOMATSU

## PC900LC-11

hydraulic excavator



### Engine power

543 HP (405 kW) @ 1,800 rpm

### Operating weight

196,652-204,368 lbs. (89,200-92,700 kg)

### Bucket capacity

3.7-8.0 yd<sup>3</sup> (2.8-6.1 m<sup>3</sup>)

# PC900LC-11

**Productivity**  
(P+ mode)

**48% up** ↗

**Fuel efficiency**  
(P+ mode)

**40% up** ↗

\*Compared with PC800LC-8E0 model (P-mode)

### Quick specs

- Engine power: 543 HP (405 kW) @ 1,800 rpm
- Operating weight: 196,652-204,368 lbs. (89,200-92,700 kg)
- Bucket capacity: 3.7-8.0 yd<sup>3</sup> (2.8-6.1 m<sup>3</sup>)



Photos may include optional equipment

# Significantly higher productivity

## Powerful and fuel efficient

- Significantly improved productivity **Upgrade**
- Three selectable work modes for high productivity or fuel efficiency **New**
- High-power SAA6D140E-7 engine **New**
- Larger single plane radiator cores for improved cooling system performance **Upgrade**
- Independent swing circuit and new hydraulic system **New**

## Integrated enhancements

- Lock lever auto lock function **New**
- Maintenance harness tie-off points **New**
- Engine shutdown secondary switch **New**
- LED lights as standard equipment **New**
- Large high-resolution LCD monitor **New**
- KomVision as a standard feature **New**

## Improved durability

- Redesigned boom and arm structures improve durability and resist bending and torsion **Upgrade**
- Restriction sensor for the hydraulic oil filter **New**

## Maintenance

- Central access service walkway **New**
- Onboard electric grease gun as standard feature **New**
- Easier cleaning of the oil cooler, air-conditioner condenser, and fuel cooler **New**
- Sealed engine cooling system **New**
- Long-life filters **Upgrade**



## Powerful workability and fuel economy

### Various work modes and settings can be selected to suit the task and purpose

- Significantly improved productivity *Upgrade*

The boosted engine output, greater bucket capacity and new P+ mode help increase productivity. The electronically controlled closed-circuit turning system has also improved multifunction.

Productivity	VS. PC800LC-8E0 P mode
In P+ mode	<b>48% up</b>

- Three selectable work modes for high productivity or fuel efficiency *New*

In addition to the conventional P mode and E mode, the newly added P+ mode allows the selection of three work modes with just one touch of the monitor switch.

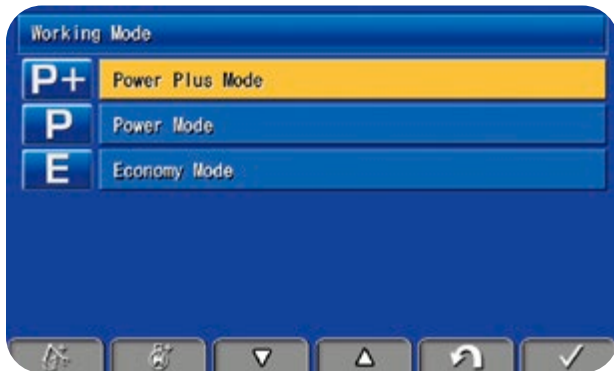

Fuel efficiency	VS. PC800LC-8E0 P mode
In P+ / P mode	<b>40% up</b>

### Its powerful and smooth operation can increase work efficiency

- High-power SAA6D140E-7 engine *New*

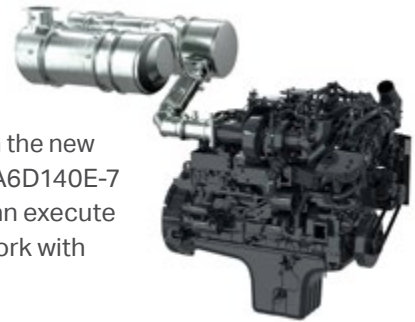

Equipped with the new enhanced SAA6D140E-7 engine, you can execute heavy-duty work with less stress.

Engine horsepower (net)	VS. PC850-8E0
486-537 HP (363-401 kW)	<b>10% up</b>

- Large digging force

The high-output engine and high-efficiency hydraulic system enable powerful digging.

Maximum arm crowd force	(ISO 6015)
<b>76,660 lbf.</b>	(341 kN)
Maximum bucket digging force	(ISO 6015)
<b>90,598 lbf.</b>	(403 kN)

- Boom raise priority mode and swing priority mode

With the monitor switch, the operator can select the priority of boom raise and swing operations to adjust the operation balance to best suit the loading work conditions.

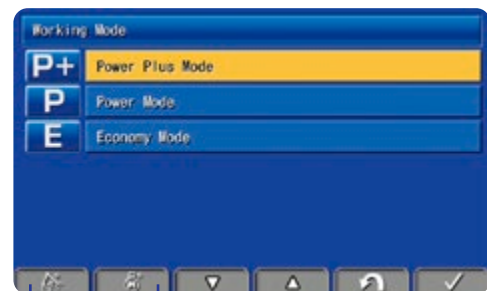

Boom raise priority mode      Swing priority mode

### Shockless boom control

The PC900LC-11 boom circuit features a shockless valve to automatically reduce the amount of shaking when operating the boom. Operator fatigue is reduced and spillage caused by shaking is minimized.

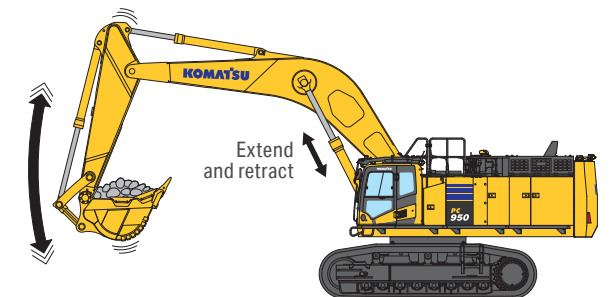

### Two-mode setting for boom

Smooth mode provides easy operation for gathering blasted rock and scraping operations. When maximum digging force is needed, switch to Power mode for more effective excavating.

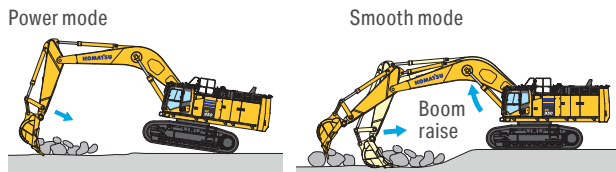

### Enhance performance and fuel efficiency

In P mode, the productivity can be increased while maintaining the same fuel consumption as conventional machines. While in E mode, the machine can operate with a greater productivity but lower fuel consumption than conventional machines. *Upgrade*

**In P mode** (Compared with PC800LC-8E0 P mode)

Productivity **40% up**

Fuel consumption **PC800LC-8E0 equivalent**

**In E mode** (Compared with PC800LC-8E0 P mode)

Productivity **26% up**

Fuel consumption **10% down**

### Improved cooling performance

The layout of the cooling cores has been optimized and the cooling package has been enlarged. The cooling performance has also been improved by adopting a new shroud shape. *Upgrade*



### New hydraulic system

An electronically controlled closed-loop swing circuit system has been adopted. Independent control of the swing and work equipment circuits enables finely tuned loading operations, contributing to reduced fuel consumption and improved workability. *New*

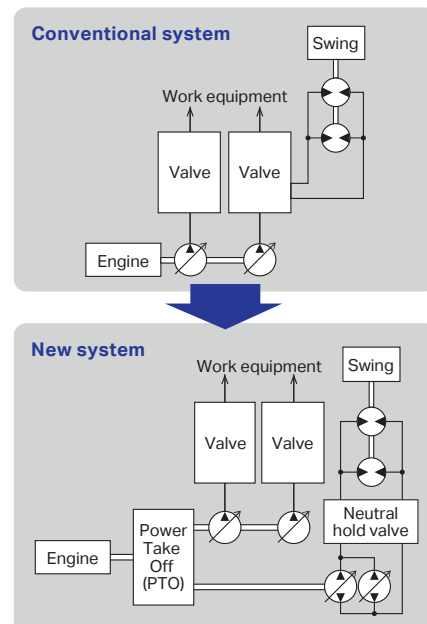

## Improved durability

### Strengthened boom and arm

- New boom and arm design to resist bending and torsion **Upgrade**

The large cross-sectional structure uses high-tensile steel, thick plates and partition wall to provide a tough design that resists bending and torsion. Partition wall and internal welding have been added at high load points on the boom, and the welding shape of the arm bosses has been optimized to extend its service life. This hydraulic excavator retains high durability and reliability over the long term, even in hard quarrying operations.

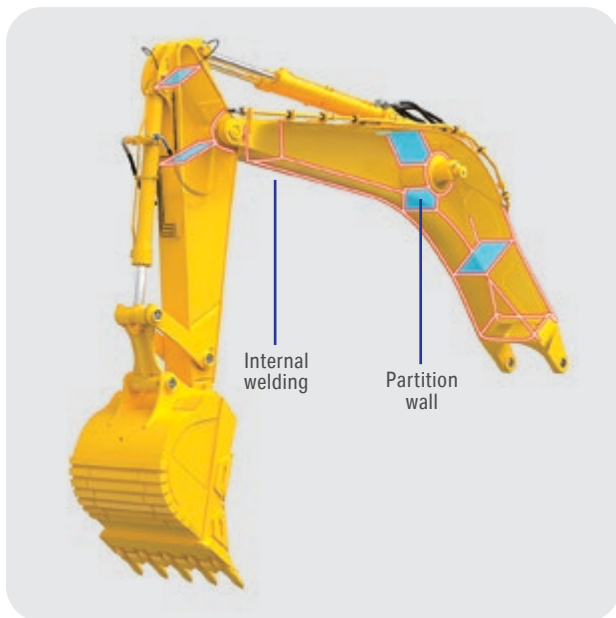

- Reinforced undercarriage

The strengthened undercarriage provides excellent reliability and durability when working on rocky ground and blasted rock. Rock protection shields the travel motors and pipings against damage.

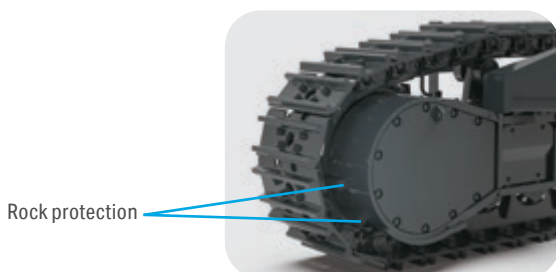

- Cooling core reinforcement

This machine features an exceptionally reliable cooling core with a proven track record in mining equipment. The durability of the core has been improved to extend its service life.

### Trouble-resistant electrical circuits

The electrical circuitry is equipped with shielded connectors that resist sagging and poor connections that may result from vibration, as well as waterproof seals that prevent water and dust from entering the connectors. In addition, a circuit breaker is provided to prevent electrical problems caused by short circuits. In the event of an intermittent problem, the hydraulic excavator can be restarted by resetting the circuit breaker switch. Also, highly reliable heat-resistant covered wires surround high-temperature parts like the engine.

### High-pressure inline filtration

The PC900LC-11 has an extensive filtration system, providing inline filters as standard equipment. An inline filter in the outlet port of each main hydraulic pump helps reduce failures caused by contamination.

- Return oil filter clog detection function **New**

This feature monitors the condition of the return oil filter in the hydraulic system and helps prevent damage by informing the operator before clogging or excessive contamination becomes an issue. The signal can be monitored via Komtrax.



## Comfortable working space



### Comfortable working space

- Wide spacious cab **New**

The spacious cab with wide field of view offers comfortable working experience even at extended hours.

The ergonomic reclining high-back air suspension seat with a heater function has deep side support for excellent hold ability and has easy-to-adjust height and front-rear inclination. With a seat-mounted console, it also has a wide range of adjustments to obtain the optimum working position.

- Low cab noise

The newly-designed cab is highly rigid and has excellent sound insulation ability.

- Arm rest with simple height adjustment function **New**

The adjustable armrest allows operators to customize the height of the armrest to their preferred ergonomic position.



- Multifunction audio **New**

Stay connected with an AM/FM radio and Bluetooth® wireless technology.



- Automatic air conditioner (A/C) **New**



- Adoption of new levers with reduced operating force

The newly designed pressure-compensated pump (PCP) valve reduces the lever operation force, enabling comfortable work with less fatigue, even after long hours of operation.

### Standard equipment:



**Sliding window glass (left side)**



**Opening and closing skylight**



**USB port for charging **New****

**Remote intermittent wiper with windshield washer**

**Defroster (Conform to the ISO 10263-5)**

**12 V auxiliary power socket**

**Document and cup holder**

## Further enhanced safety

### Operator's cab

The PC900LC-11 cab meets the requirements of the Operator Protective Guard (OPG) top guard level 1 (ISO 10262) for falling objects. OPG top guard level 2 (ISO 10262) is optional. These features, along with an additional retractable seatbelt, are designed to help promote a safer working environment for the operator.

### Lock lever auto lock function

If the work equipment lever is not in the neutral position when the hydraulic lock lever is released, the equipment is automatically stopped. The lock lever auto lock state is shown on the monitor screen. **New**



### Tie-offs

Strategically placed to help support mechanics during repairs. **New**



### Equipment

- Engine shutdown secondary switch **New**

Shuts down engine during an emergency.



- Fall prevention handrail (ISO 2867) **New**

Designed to help provide easy access to the machine for inspection and maintenance.



- Retractable seat belt

- Lock lever

When lock lever is placed in lock position all hydraulic controls (travel, swing, boom, arm, bucket and attachment) are inoperable.



- Seat belt caution indicator **New**

Reminds the operator to engage the seat belt.

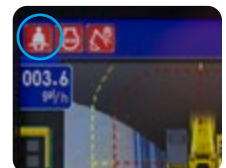

- Emergency escape hammer
- Large side mirrors
- Slip-resistant plates
- Pump/engine room partition
- Travel alarm



## LED light as standard equipment

The bright and long life LED lights are equipped as standard. Improves visibility in low-light environment to promote safe working conditions. In addition, the upper left and lower left of the cab have flashlights. **New**

## LED light installation location

- ① Front light above cab  
(LH: Interconnected horn and flashing light)
- ② Front light below cab  
(LH: Interconnected horn and flashing light)
- ③ Step light
- ④ Boom working light (RH, LH)
- ⑤ RH front light
- ⑥ RH working light
- ⑦ Cab rear light
- ⑧ Rear working light
- ⑨ Walkway light

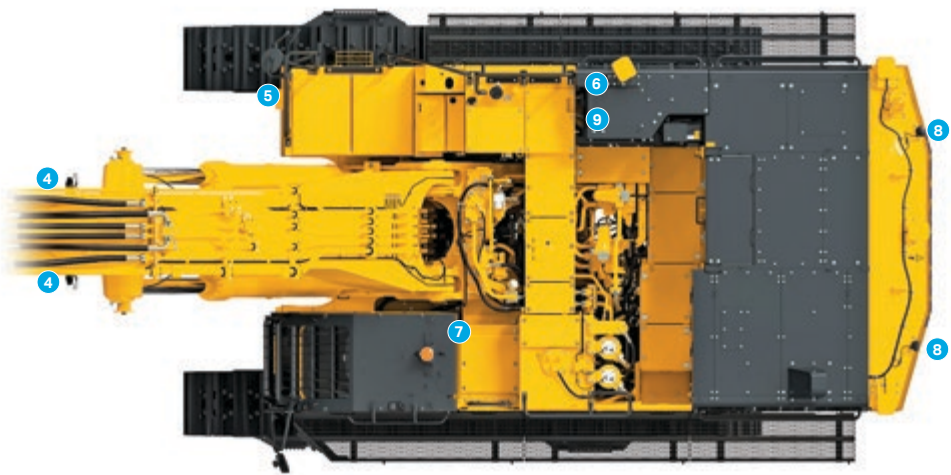

# PC900LC-11

## Machine monitor with evolutionary interface

The monitor screen features a high-quality, high-resolution LCD panel. Switches are simple and easy to use. Function switches make multifunctional operations easy. The high visibility screen has been redesigned so the required information is easier to see and understand, without loss of conventional operability. The main screen can display the surroundings clearly using standard KomVision. Images and data on the main screen can be displayed together or separately by pressing the F3 key. **New**

### Indicators

- |                            |                                     |
|----------------------------|-------------------------------------|
| 1 Auto-decelerator         | 10 Engine coolant temperature gauge |
| 2 Working mode             | 11 Hydraulic oil temperature gauge  |
| 3 Travel speed             | 12 Fuel gauge                       |
| 4 Fuel consumption gauge   | 13 DEF level gauge                  |
| 5 Camera display           | 14 DEF level caution lamp           |
| 6 Service meter            | 15 Guidance icon                    |
| 7 Camera direction display | 16 Function switches                |
| 8 Clock                    |                                     |
| 9 ECO gauge                |                                     |

### Basic operation switches

- |                         |                 |
|-------------------------|-----------------|
| 1 Auto-decelerator      | 4 Buzzer cancel |
| 2 Working mode selector | 5 Wiper         |
| 3 Travel speed selector | 6 Window washer |



## KomVision

The surroundings of the machine can be displayed on the monitor by using the four cameras installed at the sides and rear of the machine. Press the switch F4 to toggle between the right, left and rear side view of the machine. **New**

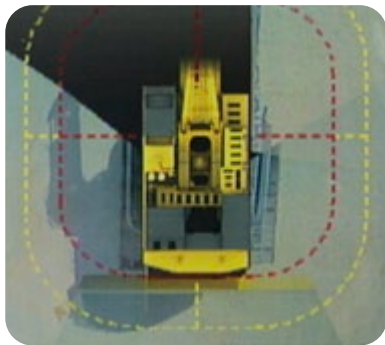

KomVision monitor display

## Visual user menu

Pressing the F6 key on the main screen displays the user menu screen, grouping the menus for each function with easy-to-understand icons to help operate the machine intuitively. **New**

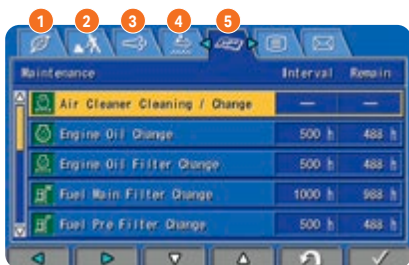

- 1 Energy saving guidance
- 2 Machine setting
- 3 Maintenance
- 4 Monitor setting
- 5 Mail check

## Support efficiency improvement

- ECO guidance

While the machine is operating, ECO guidance operation tips pop up on the monitor, guiding the operator to achieve better fuel efficiency.

- ECO gauge and fuel consumption gauge

The monitor screen includes an ECO gauge and also a fuel consumption gauge which is continuously displayed. In addition, the operator can set any desired target value of fuel consumption (within the range of the green display), enabling the machine to be operated with better fuel economy.

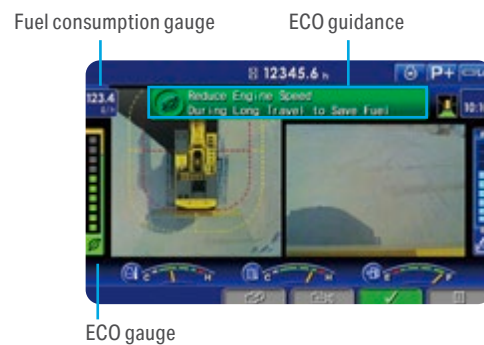

## Operation record, fuel consumption history and ECO guidance record

The ECO guidance menu enables the operator to check the operation record, fuel consumption history and ECO guidance record from the ECO guidance menu, using a single touch to help reduce fuel consumption.



Operation records

ECO guidance records



Average fuel consumption logs

# Maintenance

## Equipped with center aisle walk-through and LH and RH walkways for easy maintenance

The machine features centrally located maintenance points and walkthroughs for easy access. The front engine door opens wide for easy access to the auxiliary equipment. The standard catwalk is on the excavator's right side to promote safe inspections of the cooling area. *New*

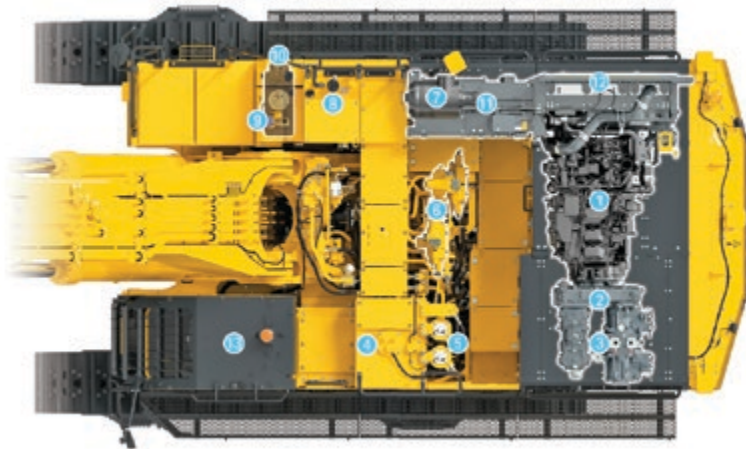

- |                        |                 |               |
|------------------------|-----------------|---------------|
| 1 Engine               | 6 Control valve | 10 DEF pump   |
| 2 PTO                  | 7 Air cleaner   | 11 Oil cooler |
| 3 Hydraulic pump       | 8 Fuel tank     | 12 Radiator   |
| 4 Hydraulic oil tank   | 9 DEF tank      | 13 Cab        |
| 5 Hydraulic oil filter |                 |               |

- Electric pump, grease gun with indicator  
Electric pump makes greasing easy.

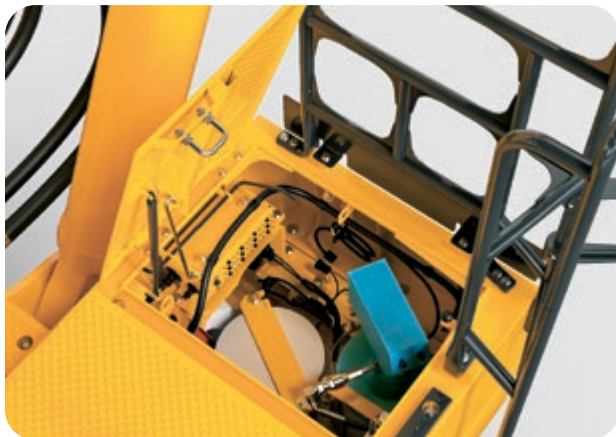

- Ground-level grease gun  
Access the grease gun on the ground-level to make grease work simple.



- Access each cooling core for simple cleaning **New**  
Easy access to the hinged air-conditioner condenser, oil cooler and fuel cooler make cleaning easier.



- Cooling unit maintenance made easy  
Hydraulic-driven fan features reverse-rotation function for easy cleaning.



- Sealed engine cooling system **New**  
This system enhances the excavator's performance, helping to improve the efficiency of the cooling process and reduce the need for maintenance tasks.



PC900LC-11: 25 L



PC800LC-8E0: 9 L×2

- Alternator, compressor belt auto tensioner **New**
- Electric priming pump **New**
- Battery disconnect switch
- Low-maintenance high-performance battery **New**  
Eliminates the inconvenience of having to top up the battery fluid.
- DEF tank **New**  
Installed on the right front stairway for ease of access. The included workbench makes refilling DEF easy.



Before fitting



After fitting

- Extended replacement interval of hydraulic oil filter **Upgrade**  
The replacement interval of the hydraulic oil filter element is extended by 2.5 times, helping contribute to the reduction of maintenance costs.

1,000 hours → **2,500** hours

## Maintenance information

- Supports the DEF level and refill timing  
The DEF level gauge is displayed continuously on the right side of the monitor screen. In addition, when the refill timing is reached, the DEF low level guidance appears as a pop-up display to inform the operator in real time.



DEF low level guidance

DEF level gauge

# PC900LC-11

- Maintenance time caution lamp display

When the remaining time to maintenance becomes less than 30 hours\*, the maintenance time monitor appears. Pressing the F6 key switches the monitor to the maintenance screen.

\*The setting can be changed within the range between 10 and 200 hours.



Maintenance screen

- Aftertreatment devices regeneration automatic display

When it is necessary to carry out manual regeneration (the manual stationary regeneration) of the Komatsu Diesel Particulate Filter (KDPF), the display automatically switches to the aftertreatment device regeneration screen to inform the operator.

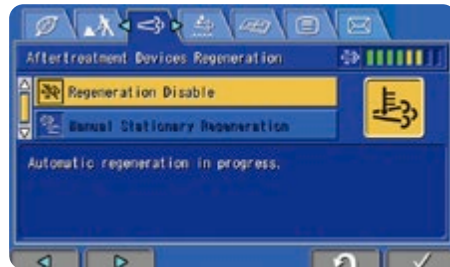

Aftertreatment device regeneration screen



## Transportation

### Large production machine designed for easy transportation between job site locations

Machine design allows for low transportation height and reduces transportation costs. Less disassembly required to meet transportation weight requirements. Removing bucket (8,598-8,818 lbs.), arm (11,244-11,685 lbs.) and counterweight (28,219 lbs.) reduces transportation weight down to under 155,000 lbs. (Actual weight may vary with different work equipment and attachments).

### Counterweight remover option

Simplifies the process of machine transportation by providing a convenient way of removing the counterweight without the use of a crane. *New*



### Variable track gauge

The track gauge can be adjusted from 139" (3,530 mm) down to 131.8" (3,347 mm) with 35.4" (900 mm) track shoes to provide narrow trailer loading capabilities.



## Introduction of specifications

### PC900LC-11

- 27.6 ft. boom
- 12'1" (3,700 mm) and 14'4" (4,400 mm) arm options
- Optional mass excavation boom and arm configuration
- Cab with two-piece pull-up window, opening and closing skylight
- Additional track roller guard





# Lift charts

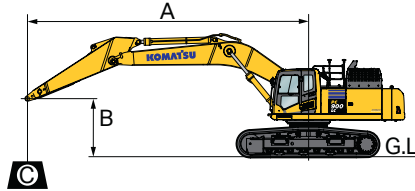

- A: Reach from swing center
- B: Bucket hook height
- C: Lifting capacity
- Cf: Rating over front
- Cs: Rating over side
- ⊗ Rating at maximum reach

- Conditions:
- Boom length: 8,400 mm 27' 6"
  - Bucket: None
  - Undercarriage: Wide gauge

Arm: 12'11"		Track Shoes: 35.4"										Unit: lbs. kg		
B	A	Max	3.0 m 10'		4.6 m 15'		6.1 m 20'		7.6 m 25'		9.1 m 30'		Max ⊗	
			Cf	Cs	Cf	Cs	Cf	Cs	Cf	Cs	Cf	Cs		
20'							* 62,400	* 62,400	* 51,100	* 51,100	* 44,500	44,000	* 26,800	* 26,800
6.1 m							28,300	28,300	23,200	23,200	20,149	19,950	12,150	12,150
10'							* 79,200	* 71,700	* 60,600	* 52,400	* 49,900	40,400	* 28,500	* 26,600
3.0 m							35,900	32,500	27,500	23,750	22,600	18,350	12,950	12,050
0'							* 80,600	* 67,600	* 63,700	48,900	* 52,000	38,000	* 33,100	29,900
0 m							36,550	30,650	28,900	22,200	23,600	17,200	15,050	12,200
-10'		* 62,700	* 62,700	* 84,500	* 84,500	* 70,000	67,900	* 57,300	48,500	* 46,800	37,600	* 37,600	31,400	
-3.0 m		28,450	28,450	38,300	38,300	31,750	30,800	26,000	22,000	21,250	17,050	17,050	14,250	
-20'							* 44,300	* 44,300	* 34,300	* 34,300			* 31,100	* 31,100
-6.1 m							20,100	20,100	15,550	15,550			14,100	14,100

\*Asterisk indicates load is limited by hydraulic capacity rather than tipping. Ratings are based on ISO standard No. 10567. Rated load capacity does not exceed 87% of hydraulic lift capacity or 75% of tipping load. Total weight of bucket and/or installed attachments must be deducted from the capacities shown above. Lift capacity chart is based on machine located on a solid, level and uniform surface. Load ratings are at the arm bucket pin location, use of any attachment point in a different location to handle objects could affect excavator lift performance.

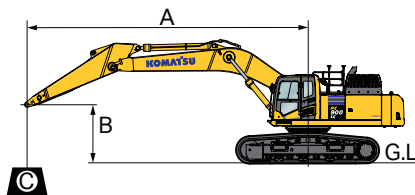

- A: Reach from swing center
- B: Bucket hook height
- C: Lifting capacity
- Cf: Rating over front
- Cs: Rating over side
- ⊗ Rating at maximum reach

- Conditions:
- Boom length: 8,400 mm 27' 6"
  - Bucket: None
  - Undercarriage: Wide gauge

Arm: 14'5"		Track Shoes: 35.4"										Unit: lbs. kg				
B	A	Max	3.0 m 10'		4.6 m 15'		6.1 m 20'		7.6 m 25'		9.1 m 30'		Max ⊗			
			Cf	Cs	Cf	Cs	Cf	Cs	Cf	Cs	Cf	Cs				
20'									* 48,000	* 48,000	* 42,200	42,200	* 21,600	* 21,600		
6.1 m									21,750	21,750	19,150	19,150	9,800	9,800		
10'									* 75,900	73,700	* 58,400	53,400	* 48,300	41,000	* 22,900	22,900
3.0 m									34,400	33,450	26,500	24,250	21,900	18,600	10,350	10,350
0'									* 81,500	68,000	* 63,500	49,200	* 51,800	38,100	* 26,300	24,700
0 m									36,950	30,800	28,800	22,350	23,500	17,300	11,900	11,200
-10'		* 55,900	* 55,900	* 79,300	* 79,300	* 73,900	67,300	* 59,500	48,200	* 48,700	37,200	* 34,100	28,300			
-3.0 m		25,350	25,350	35,950	35,950	33,500	30,550	27,000	21,850	22,100	16,900	15,450	12,850			
-20'				63,400	* 63,400	* 52,600	* 52,600	* 42,300	* 42,300				* 32,200	* 32,200		
-6.1 m				28,750	28,750	23,850	23,850	19,200	19,200				14,600	14,600		

\*Asterisk indicates load is limited by hydraulic capacity rather than tipping. Ratings are based on ISO standard No. 10567. Rated load capacity does not exceed 87% of hydraulic lift capacity or 75% of tipping load. Total weight of bucket and/or installed attachments must be deducted from the capacities shown above. Lift capacity chart is based on machine located on a solid, level and uniform surface. Load ratings are at the arm bucket pin location, use of any attachment point in a different location to handle objects could affect excavator lift performance.

# PC900LC-11

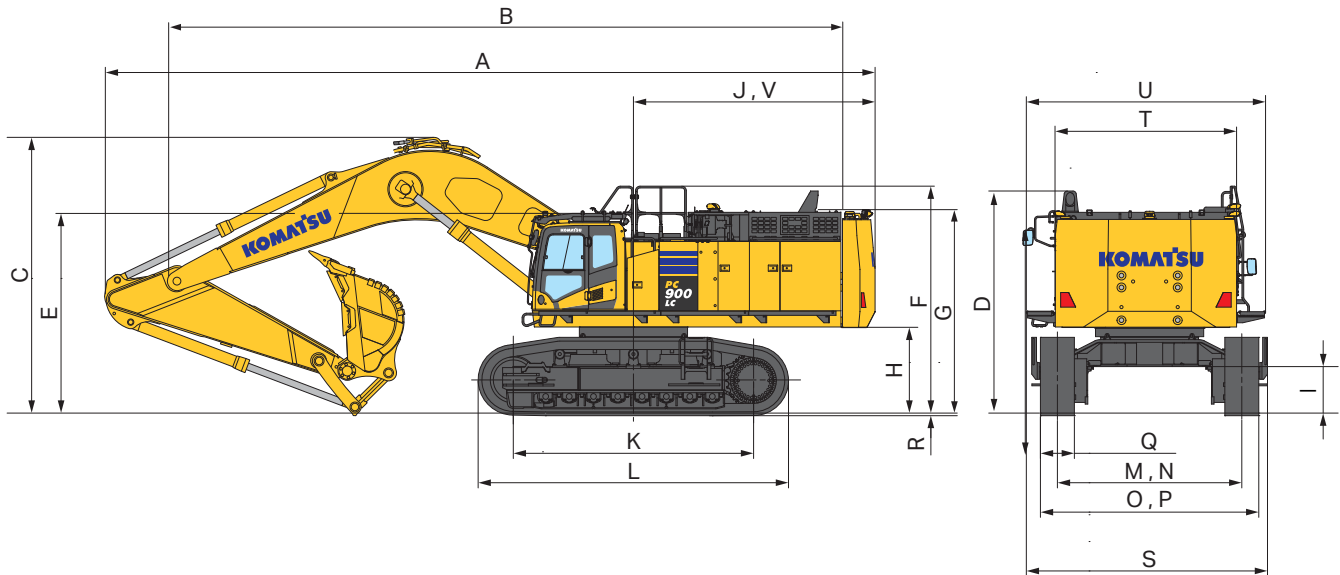

## Dimensions / working range

Dimensions	in
A Overall length	48' 6"
B Length (transport configuration)	42' 3"
C Overall height (to top of boom)*	16' 5"
D Overall height (to top of upper)*	13' 10"
E Overall height (to top of cab)*	12' 2"
F Overall height (to top of handrail)*	14' 2"
G Transport height*	12' 10"
H Ground clearance, counterweight	5' 4"
I Ground clearance, minimum	2' 11"
J Tail swing radius	15' 2"
K Track length on ground	16' 6"
L Track length	20' 9"
M Track gauge	11' 7"
N Track gauge - when retracted	11'
O Width of crawler	14' 4"
P Width of crawler - when retracted	13' 3"
Q Shoe width	2' 11"
R Grouser height	2"
S Overall width	15' 10"
T Machine upper width	11' 5"
U Machine upper width, including walkway	15'
V Distance, swing center to rear end	15' 2"

\*Including grouser height

## Bucket compatibility

Boom	Arm	Track shoe	Maximum bucket width		Maximum total load with pin-on bucket (payload + bucket)
27'6" (8,383 mm)	12'1" (3,683 mm)	2' 11" (900 mm)	7' 1" (2,154 mm)	General configuration	30,375 lbs. (13,777 kg)
27'6" (8,383 mm)	14'4" (4,368 mm)	2' 11" (900 mm)	6' 9" (2,057 mm)		24,300 lbs. (11,022 kg)
23'4" (7,112 mm)	9'6" (2,895 mm)	2' 11" (900 mm)	7' 10" (2,387 mm)	Mass excavation configuration	41,250 lbs. (18,710 kg)

Komatsu only recommends the use of buckets or other attachments that are appropriately sized for this excavator and material being handled. Exceeding the maximum total load may result in reduced performance, stability or productivity.

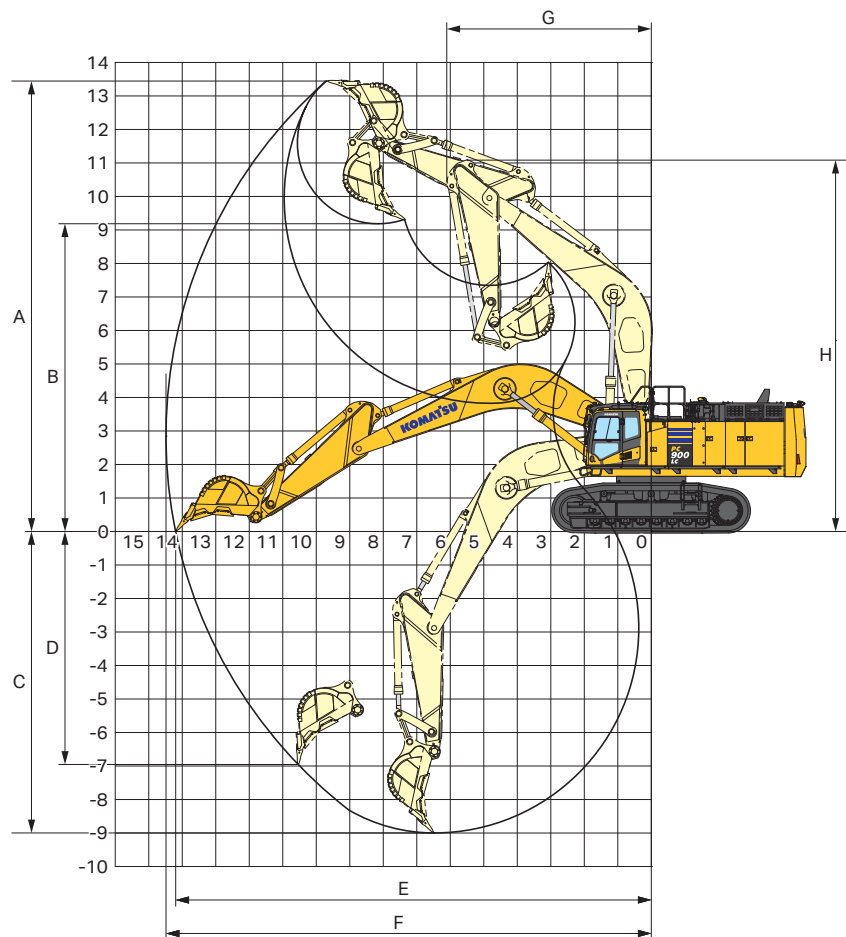

## PC900LC-11 specifications

Boom	STD boom 27' 1"	
Arm	STD arm	Semi-long arm
A Max. digging height	44' 3"	44' 3"
B Max. dumping height	30' 1"	31' 1"
C Max. digging depth	29' 7"	31' 11"
D Max. vertical wall digging depth	23' 9"	25' 1"
E Max. digging depth of cut for 8' level	46' 7"	48' 9"
F Max. digging reach	47' 6"	49' 8"
G Min. swing radius	20'	20'
H Min. swing radius height	36' 7"	36' 7"

## Specifications

### Engine

Model	Komatsu SAA6D140E-7
Type	4-cycle, water-cooled, direct injection
Aspiration T	Turbocharged, aftercooled, cooled EGR
Number of cylinders	6
Bore	5.5 in (140 mm)
Stroke	6.5 in (165 mm)
Piston displacement	930 in <sup>3</sup> (15.24 L)
Governor	All-speed, electronic
Horsepower:	
SAE J 1995 Gross	543 HP (405 kW)
ISO 14396	543 HP (405 kW)
ISO 9249 / SAE J1349*	538 HP (401 kW)
Rated rpm	1,800 rpm
Fan drive type	Hydraulic

\* Net horsepower at the maximum speed of radiator cooling fan is 374 kW 501 HP.

U.S. EPA Tier 4 Final and EU Stage 5 emissions equivalent.

### Hydraulic system

Type	Open-center load-sensing system
Number of selectable working modes	3
Main pump:	
Type	Variable-capacity piston pumps
Pumps for	Boom, arm, bucket, swing, and travel circuits
Maximum flow	318.6 gpm (1,206 L/min)
Fan drive pump	Variable capacity piston type
Hydraulic motors:	
Travel	2 x axial piston motor with parking brake
Swing	2 x axial piston motor with swing holding brake
Relief valve setting:	
Implement circuits	34.3 MPa (350 kgf/cm <sup>2</sup> )
Travel circuit	34.3 MPa (350 kgf/cm <sup>2</sup> )
Swing circuit	27.0 MPa (275 kgf/cm <sup>2</sup> )
Pilot circuit	2.9 MPa (30 kgf/cm <sup>2</sup> )
Hydraulic cylinders (number of cylinders – bore x stroke x rod diameter):	
Boom	2 – 8.3 x 82 x 5.9 in
Arm (STD)	2 – 6.7 x 84.3 x 4.7 in
(Mass excavation)	2 – 7.3 x 65.8 x 4.7 in
Bucket (STD)	1 – 7.3 x 74.5 x 5.1 in
(Mass excavation)	1 – 8.9 x 65.3 x 6.3 in

### Swing system

Driven method	Hydraulic motors (2)
Swing reduction	Planetary gear
Swing circle lubrication	Grease-bathed
Swing lock	Oil disc brake
Swing speed	6.8 rpm

### Drives and brakes

Steering control	Two levers with pedals
Drive method	Fully hydrostatic
Travel motor	Axial piston motor, in-shoe design
Reduction system	Planetary gear triple reduction
Maximum drawbar pull	
PC900LC-11	56,000 lbs.
Gradeability	70%
Maximum travel speed (Lo / Hi)	
PC900LC-11	1.7/2.6 mph
Service brake	Hydraulic lock
Parking brake	Oil disc brake

### Undercarriage

Center frame	H-leg frame
Track frame	Box-section
Seal of track	Sealed
Track adjuster	Hydraulic
Number of shoes (each side)	
PC900LC-11	51
Number of carrier rollers (each side)	3
Number of track rollers (each side)	
PC900LC-11	9

### Coolant and lubricant capacity (refilling)

Fuel tank	276.1 gal
Radiator	24.4 gal
Engine	14 gal
Final drive (each side)	
PC900LC-11	5.3 gal
Swing drive	6.3 gal
Hydraulic tank	142.7 gal
DEF tank	16.4 gal

### Operating weight (approximate)

#### PC900LC-11:

Operating weight, including 27'6" (8.4 m) boom, 12'1" (3.7 m) arm, 6.5 yd<sup>3</sup> (5 m<sup>3</sup>) heaped backhoe bucket, operator, lubricant, coolant, full fuel tank and the standard equipment.

#### PC900LC-11

Shoes	Operating weight	Ground pressure
35.4 in (900 mm)	204,368.5 lbs. (92,700 kg)	13.34 psi

### Transport weight

	Component	Weight (kg)	Weight (lbs.)
Removed parts	145.7" (3,700 mm) arm assembly	5,000	11,023
	Counterweight	12,780	28,175
	Handrails, steps, walkways, etc.	690	1,521
Machine weight (includes boom, tracks, full fuel tank)		70,290	154,963



PC900LC-11



# Transportation guide

## Major component weights

Major component dimensions (length x height x width) specs shown include the following equipment: *Reference field assembly manual GEN00251-00 for additional information.*



### Work equipment assembly Boom

	Weight	Length	Width	Height
8,400 mm	(9,560 kg)	(8,760 mm)	(1,640 mm)	(2,520 mm)
27'6" Boom	21,076 lbs.	28'9"	65"	8'3"



### Arms

Short Arm		12'1" (3,700 mm)
Weight		11,023 lbs. (5,000 kg)
Length		16'7" (5,080 mm)
Width		3'1" (945 mm)
Height		5'1" (1,560 mm)
Semi-Long Arm		11'2" (4,400 mm)
Weight		11,309 lbs. (5,130 kg)
Length		19'0" (5,785 mm)
Width		3'1" (945 mm)
Height		5'2" (1,575 mm)



### Arm cylinders

1,151 lbs. (552 kg) each	Length: 7'9" (2,352 mm)
--------------------------	-------------------------



### Boom cylinders

2,028 lbs. (920 kg) each	Length: 11'2" (3,410 mm)
--------------------------	--------------------------

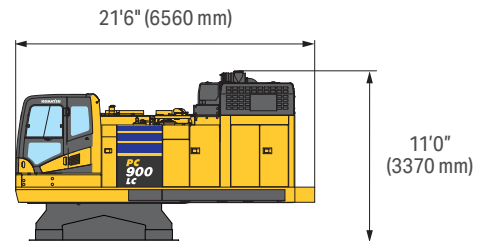

### Upper structure

Width	11'4" (3,475 mm)
Weight	71,650 lbs. (32,500 kg)

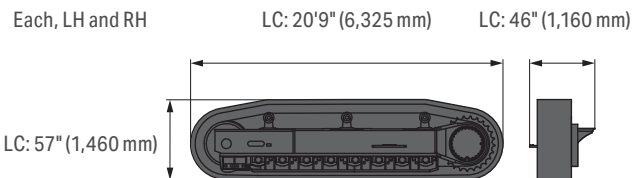

### Undercarriage

Weight	LC: 28,219 lbs. (12,800 kg) each side
--------	---------------------------------------

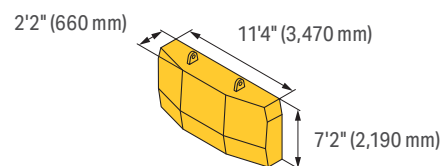

### Counterweight

Counterweight mass (fixed)	29,100 lbs. (13,200 kg)
Counterweight mass (removal device spec)	28,175 lbs. (12,780 kg)

# Standard and optional equipment

## Engine

Alternator and A/C compressor belt auto-tensioner	●
Automatic engine warm-up system	●
Dry type air cleaner, double element	●
Engine, Komatsu SAA6D140E-7	●
Fuel pre-filter with water separator	●
Variable speed cooling fans (2), hydraulic drive, reversible	●

## Electrical system

Alternator, 24 V/90 A	●
Auto-decelerator and auto idle shutdown	●
Batteries, 2 x 12 V/196 Ah (high-performance batteries)	●
Battery disconnect switch /lock out-tag out	●
Circuit breaker	●
Horn, electric	●
Starting motor, 24 V/11 kW	●
Working LED light (two boom, four cab, two right front)	●
Two LEDs on the cab are linked to the horn (for truck loading)	●
Rear LED light (2 counterweight)	●
Central aisle maintenance LED light (2)	●
Cab access step light with timer	●

## Hydraulic system

Three-mode system (P+, P, E)	●
Inline high pressure filters	●
Pressure proportional control (PPC) hydraulic control system	●
Two-mode setting for boom	●
Shockless control system for boom	●

## Guards and covers

Fan guard structure	●
Strengthened revolving frame underguard	●

## Undercarriage

Hydraulic track adjusters (each side)	●
Track roller (nine on each side)	●
2' 11" (900 mm) double grouser shoes	○

Further equipment on request ● standard equipment ○ optional equipment

## Operator environment

Auto climate control with defroster	●
Multifunction audio (with Bluetooth)	●
Cab with pull-up type front window	●
Engine shutdown secondary switch	●
High-back suspension seat, heated	●
Large high resolution LCD monitor	●
Operator controls hydraulic lock lever	●
Operator protective top guard (OPG), level 1 (ISO 10262)	●
Mirrors (RH, LH)	●
KomVision camera system	●
Seat belt, retractable, 3.1" (78 mm)	●
Washable cab floor mat	●
Short joystick levers	●
Rain visor	○
Sun visor	○
Lower wiper	○
Beacon lamp	○

## Work equipment

12' 2" (3,700 mm) arm assembly	○
14' 5" (4,400 mm) arm assembly	○
9' 8" (2,945 mm) SE arm assembly (mass excavation)	○
27' 7" (8,400 mm) boom assembly	○
23' 4" (7,100 mm) SE boom assembly (mass excavation)	○

## Other equipment

Equipment Management Monitoring System	●
Grease gun, electric pump type	●
Hand rails and guard rails	●
Komtrax	●
Preventive Maintenance (PM) tune-up service connector	●
Rear reflector	●
Slip-resistant plates	●
Travel alarm	●
Wide walkway (RH and LH)	●
Fuel, fast fill provision	●
Counterweight removal device	○
Quick oil sampling ports	●
Tool kit *optional for North American spec	○

Product designs, specifications and/or data in this document are provided for information purposes only and are not warranties of any kind. Product designs and/or specifications may be changed at any time without notice. The only warranties that apply to sales of products and services are Komatsu's standard written warranties, which will be furnished upon request.

Komatsu and other trademarks and service marks used herein are the property of Komatsu Ltd. or its subsidiaries, or the respective owners or licensees.

# KOMATSU

[komatsu.com](https://www.komatsu.com)

