

# KOMATSU®

## PC240LC-11

Tier 4 Final Engine

### HYDRAULIC EXCAVATOR

# PC240LC



Photos may include optional equipment.

#### NET HORSEPOWER

177 HP @ 2000 rpm  
132 kW @ 2000 rpm

#### OPERATING WEIGHT

55,763–56,360 lb  
25294–25574 kg

#### BUCKET CAPACITY

0.76–1.85 yd<sup>3</sup>  
0.58–1.42 m<sup>3</sup>

# WALK-AROUND

PC240LG-11



Photos may include optional equipment.

## NET HORSEPOWER

177 HP @ 2000 rpm  
132 kW @ 2000 rpm

## OPERATING WEIGHT

55,763–56,360 lb  
25294–25574 kg

## BUCKET CAPACITY

0.76–1.85 yd<sup>3</sup>  
0.58–1.42 m<sup>3</sup>



## PERFORMANCE & EFFICIENCY

### Enhanced Power Mode

Enhanced engine and hydraulic pump control logic improves multi-function speed for up to 4% improved productivity.

### Komatsu Harmony

All major components are designed and manufactured by Komatsu. A fully integrated design produces an efficient, reliable system.



A powerful **Komatsu SAA6D107E-3 engine** provides a net output of 132 kW **177 HP**. This engine is EPA Tier 4 Final emissions certified.

**Variable Geometry Turbocharger (VGT)** uses a hydraulic actuator to provide optimum air flow under all speed and load conditions.

**Komatsu Diesel Particulate Filter (KDPF) and Selective Catalytic Reduction (SCR) system** reduce particulate matter and NOx while providing automatic regeneration that does not interfere with daily operation.

**Komatsu's Closed-center Load Sensing System (CLSS)** provides quick response and smooth operation to maximize productivity.

**Enhanced working modes** are designed to match engine speed, pump delivery, and system pressure to the application.

The **KOMTRAX®** telematics system is standard on Komatsu equipment with no subscription fees. Using the latest wireless technology, **KOMTRAX®** transmits valuable information such as location, utilization, and maintenance records to a PC or smartphone app. Custom machine reports are provided for identifying machine efficiency and operating trends. **KOMTRAX®** also provides advanced machine troubleshooting capabilities by continuously monitoring machine health.

#### Large LCD color monitor panel:

- 7" high resolution screen
- Provides "Ecology Guidance" for fuel efficient operation
- Enhanced attachment control

#### Rearview monitoring system (standard)

**Equipment Management Monitoring System (EMMS)** continuously monitors machine operation and vital systems to identify machine issues and assist with troubleshooting.

#### Enhanced working environment

- High back, heated air suspension operator seat with new adjustable arm rests
- Integrated ROPS cab design (ISO 12117-2)
- Cab meets ISO Level 1 Operator Protective Guard (OPG) top guard (ISO 10262)
- Aux jack and (2) 12V power outlets

**Wide access service doors** provide easy access for ground level maintenance.

**Handrails (standard)** on both sides provide more convenient access to the upper structure.

**Battery disconnect switch** allows a technician to disconnect the power supply before servicing the machine.

#### Komatsu designed and manufactured components

**Komatsu Auto Idle Shutdown** helps reduce idle time and reduce operating costs.

**Operator Identification System** can track machine operation for up to 100 operators.

# PERFORMANCE FEATURES

## KOMATSU NEW ENGINE TECHNOLOGIES

### New Tier 4 Final Engine

The Komatsu SAA6D107E-3 engine is EPA Tier 4 Final emissions certified and provides exceptional performance and efficiency. Based on Komatsu proprietary technologies developed over many years, this new diesel engine reduces nitrogen oxides (NOx) by more than 80% when compared to Tier 4 interim levels. Through the in-house development and production of engines, electronics, and hydraulic components, Komatsu has achieved great advancements in technology, providing high levels of performance and efficiency in virtually all applications.

### Technologies Applied to New Engine

#### Heavy-duty aftertreatment system

This new system combines a Komatsu Diesel Particulate Filter (KDPF) and Selective Catalytic Reduction (SCR). The SCR NOx reduction system injects the correct amount of Diesel Exhaust Fluid (DEF) at the proper rate, thereby decomposing NOx into non-toxic water vapor (H<sub>2</sub>O) and nitrogen gas (N<sub>2</sub>).

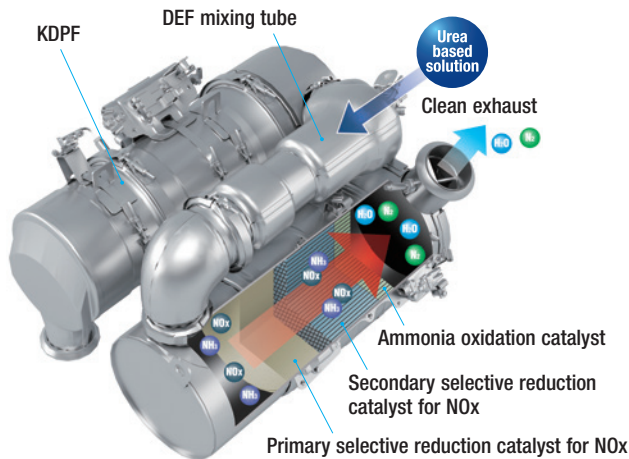

#### Heavy-duty cooled Exhaust Gas Recirculation (EGR) system

The system recirculates a portion of exhaust gas into the air intake and lowers combustion temperatures, thereby reducing NOx emissions. EGR gas flow has been decreased for Tier 4 Final with the addition of SCR technology. The system achieves a dynamic reduction of NOx, while helping maintain T4 interim fuel consumption rates.

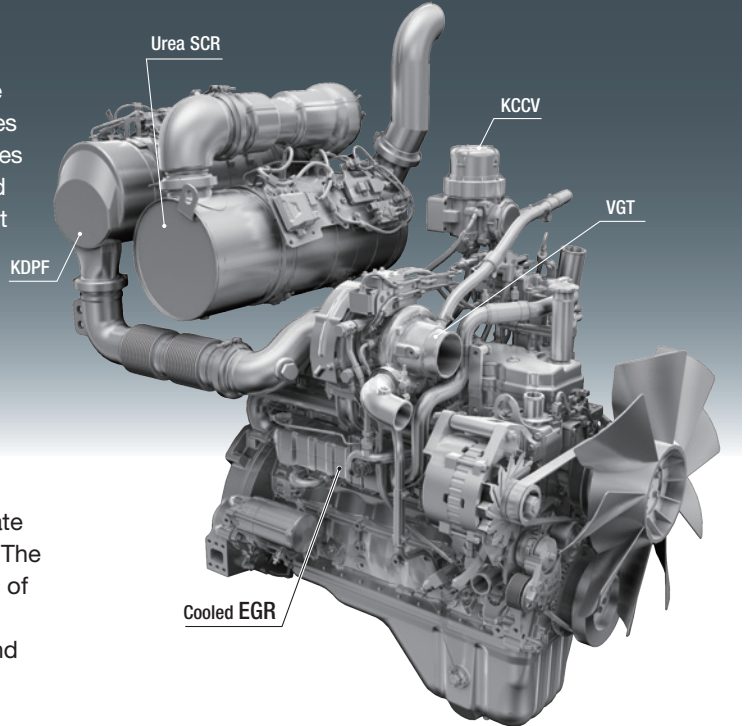
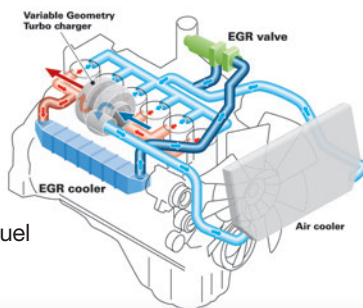

#### Advanced Electronic Control System

The electronic control system performs high-speed processing of all signals from sensors installed in the vehicle providing total control of equipment in all conditions of use. Engine condition information is displayed via an on-board network to the monitor inside the cab, providing necessary information to the operator. Additionally, managing the information via KOMTRAX helps customers keep up with required maintenance.

#### Variable Geometry Turbocharger (VGT) system

The VGT system features proven Komatsu designed hydraulic technology for variable control of air-flow and supplies optimal air according to load conditions. The upgraded version provides better exhaust temperature management.

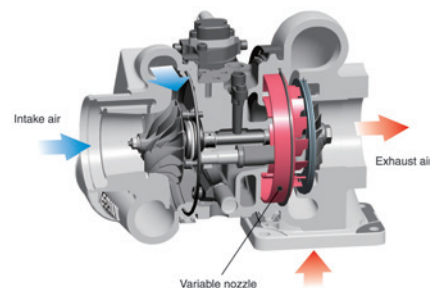

## Komatsu Auto Idle Shutdown

Komatsu auto idle shutdown automatically shuts the engine down after idling for a set period of time to reduce unnecessary fuel consumption and exhaust emissions. The amount of time before the engine is shutdown can be easily programmed from 5 to 60 minutes.



## Heavy-Duty High-Pressure Common Rail (HPCR) Fuel Injection System

The system is designed to achieve an optimal injection of high-pressure fuel by means of computerized control, providing close to complete combustion to reduce PM emissions. While this technology is already used in current engines, the new system uses high pressure injection, thereby reducing PM emissions over the entire range of engine operating conditions. The Tier 4 Final engine has advanced fuel injection timing for reduced soot levels.

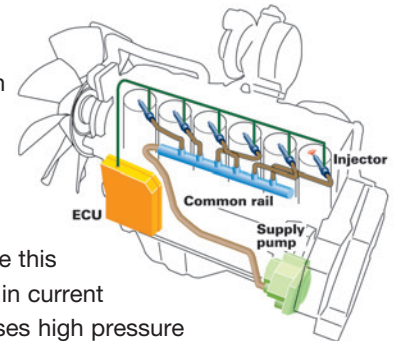

## Enhanced Productivity

The PC240LC-11's enhanced P Mode provides more hydraulic flow and increases productivity.

### Productivity

# Up to 4% increase

(compared to the PC240LC-10 in standard P Mode)

P mode (90° swing and loading onto truck)



# PERFORMANCE FEATURES

## Increased Work Efficiency

### Powerful digging force

Functional digging force can be increased with use of the one-touch Power Max. function (up to 8.5 seconds of operation).

#### Maximum arm crowd force (ISO)

**121 kN(12.3t) ➔ 129 kN(13.2t) 7% UP**  
(with Power Max.)

#### Maximum bucket digging force (ISO)

**159 kN(16.2t) ➔ 172 kN(17.5t) 8% UP**  
(with Power Max.)

Measured with Power Max. function, 3045 mm arm and ISO rating



## Large Displacement High Efficiency Pump

Large displacement hydraulic implement pumps provide high flow output at lower engine RPM as well as operation at the most efficient engine speed.

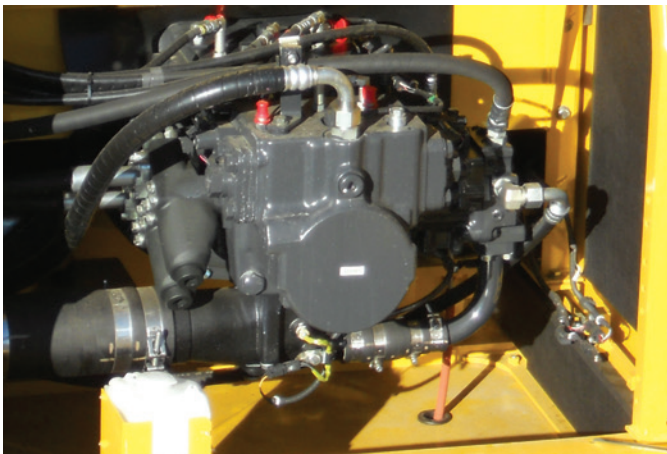

## Working Mode Selection

The PC240LC-11 excavator is equipped with six working modes (P, E, L, B, ATT/P and ATT/E). Power Mode provides improved hydraulic power and faster cycle times for improved performance in demanding applications. Each mode is designed to match engine speed, pump flow, and system pressure to the application. The PC240LC-11 features an attachment mode (ATT/E) that allows operators to run attachments while in Economy mode.

Working Mode	Application	Advantage
P	Power Mode	•Maximum production, power & multifunction
E	Economy Mode	•Good cycle times with reduced fuel consumption
L	Lifting Mode/ Fine Control	•Increased lifting power & fine control
B	Breaker Mode	•One way flow for hydraulic breaker operation
ATT/P	Attachment Power Mode	•Two way flow with maximum power
ATT/E	Attachment Economy Mode	•Two way flow with most efficient fuel economy

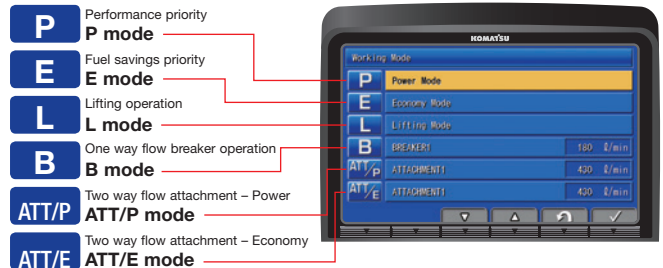

## High Rigidity Work Equipment

Booms and arms are constructed with thick plates of high tensile strength steel. In addition, these structures are designed with large cross sectional areas and large one piece steel castings in the boom foot, the boom tip, and the arm tip. The result is work equipment that exhibits long term durability and high resistance to bending and torsional stress. A standard HD boom design provides increased strength and reliability.





## Comfortable Working Space

### Wide spacious cab

The wide spacious cab includes a heated air suspension seat with reclining backrest. The seat height and position are easily adjusted using a pull-up lever. The armrest position is easily adjusted together with the console. Reclining the seat further enables it to be fully laid back with the headrest attached.

### Arm rest with simple height adjustment function

A knob and plunger on the armrests allows easy height adjustment without the use of tools.



### Low vibration with cab damper mounting

### Automatic climate control

### Pressurized cab

### Auxiliary input jack

Connecting a regular audio device to the auxiliary jack allows the operator to hear the sound from the stereo speakers installed in the cab.



## Standard Equipment

Sliding window glass (left side)



Radio, ashtray



Remote intermittent wiper with windshield washer



Cigarette lighter



Opening & closing skylight



Magazine box & cup holder



Defroster (conforms to the ISO standard)



One-touch storable front window lower glass



# WORKING ENVIRONMENT

PC240LG-11

## LARGE HIGH RESOLUTION LCD MONITOR



### New Monitor Panel Interface Design

An updated large high resolution LCD color monitor enables accurate and smooth work. The interface has been redesigned to display key machine information in a new user friendly interface. A rear view camera and a DEF level gauge display have been added to the default main screen. The interface has a function that enables the main screen mode to be switched, thus enabling the optimum screen information for the particular work situation to be displayed.

#### Indicators

- |                                    |                             |
|------------------------------------|-----------------------------|
| 1 Auto-decelerator                 | 8 Fuel gauge                |
| 2 Working mode                     | 9 DEF level gauge           |
| 3 Travel speed                     | 10 Service meter, clock     |
| 4 Ecology gauge                    | 11 Fuel consumption gauge   |
| 5 Camera display                   | 12 Guidance icon            |
| 6 Engine coolant temperature gauge | 13 Function switches        |
| 7 Hydraulic oil temperature gauge  | 14 Camera direction display |
|                                    | 15 DEF level caution lamp   |

#### Basic operation switches

- |                         |                         |
|-------------------------|-------------------------|
| 1 Auto-decelerator      | 4 Buzzer cancel         |
| 2 Working mode selector | 5 Wiper                 |
| 3 Travel speed selector | 6 Window washer         |
|                         | 7 Auto climate controls |

### Switchable Display Modes

The main screen display mode can be changed by pressing the pressing the F3 key.

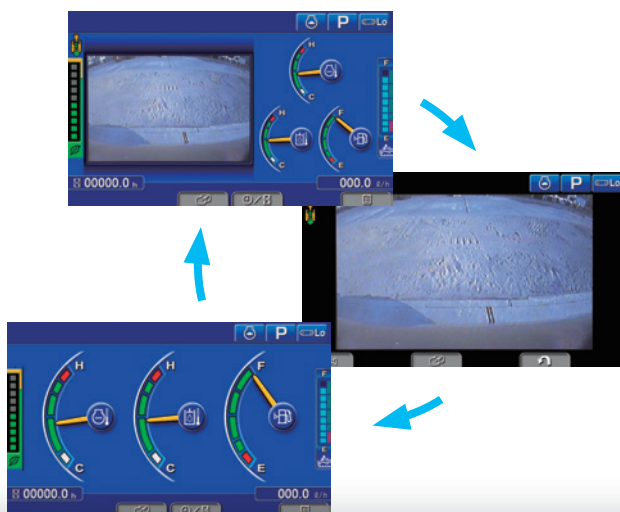

### Visual user menu

Pressing the F6 key on the main screen displays the user menu screen. The menus are grouped for each function, and use easy-to-understand icons which enable the machine to be operated easily.



- 1 Energy saving guidance
- 2 Machine settings
- 3 Aftertreatment devices regeneration
- 4 SCR information
- 5 Maintenance
- 6 Monitor setting
- 7 Message check



## Support Efficiency Improvement

### Ecology guidance

While the machine is operating, ecology guidance pops up on the monitor screen to notify the operator of the status of the machine in real time.

### Ecology gauge & fuel consumption gauge

The monitor screen is provided with an ecology gauge and also a fuel consumption gauge which is displayed continuously. In addition, the operator can set any desired target value of fuel consumption (within the range of the green display), enabling the machine to be operated with better fuel economy.



Ecology gauge      Fuel consumption gauge  
Ecology guidance

### Operation record, fuel consumption history, and ecology guidance record

The ecology guidance menu enables the operator to check the operation record, fuel consumption history and ecology guidance record from the ecology guidance menu, using a single touch, thus assisting operators with reducing total fuel consumption.



Operation record



Fuel consumption history

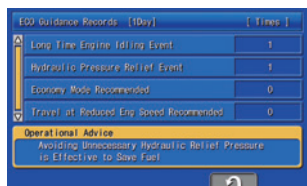

Ecology guidance record

## Operator Identification Function

An operator identification ID can be set up for each operator, and used to manage operation information of individual machines using KOMTRAX data. Data sent from KOMTRAX can be used to analyze operation status by operator as well as by machine.



# MAINTENANCE FEATURES

## Centralized engine check points

Locations of the engine oil check and filters are integrated into one side to allow easy maintenance and service.

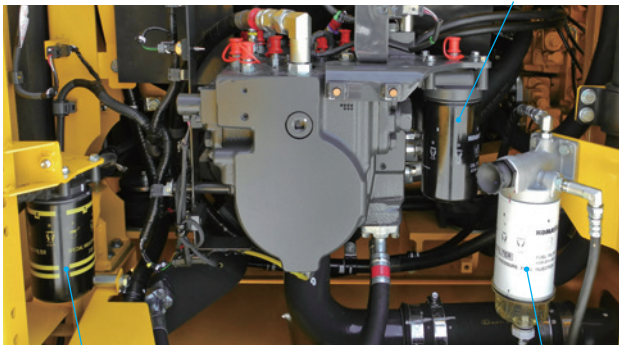

Engine oil filter

High efficiency fuel filter

Fuel pre-filter (with water separator)

## Battery disconnect switch

A standard battery disconnect switch allows a technician to disconnect the power supply and lock out before servicing the machine.



## Easy to access air conditioner filter

## Washable cab floor mat

## Sloping track frame

## Utility space

## Easy cleaning of cooling unit

## Fuel pre-filter with water separator

## High efficiency primary fuel filter

## Easy access to engine oil filter, engine oil, drain valve, fuel drain valve and water separator drain valve

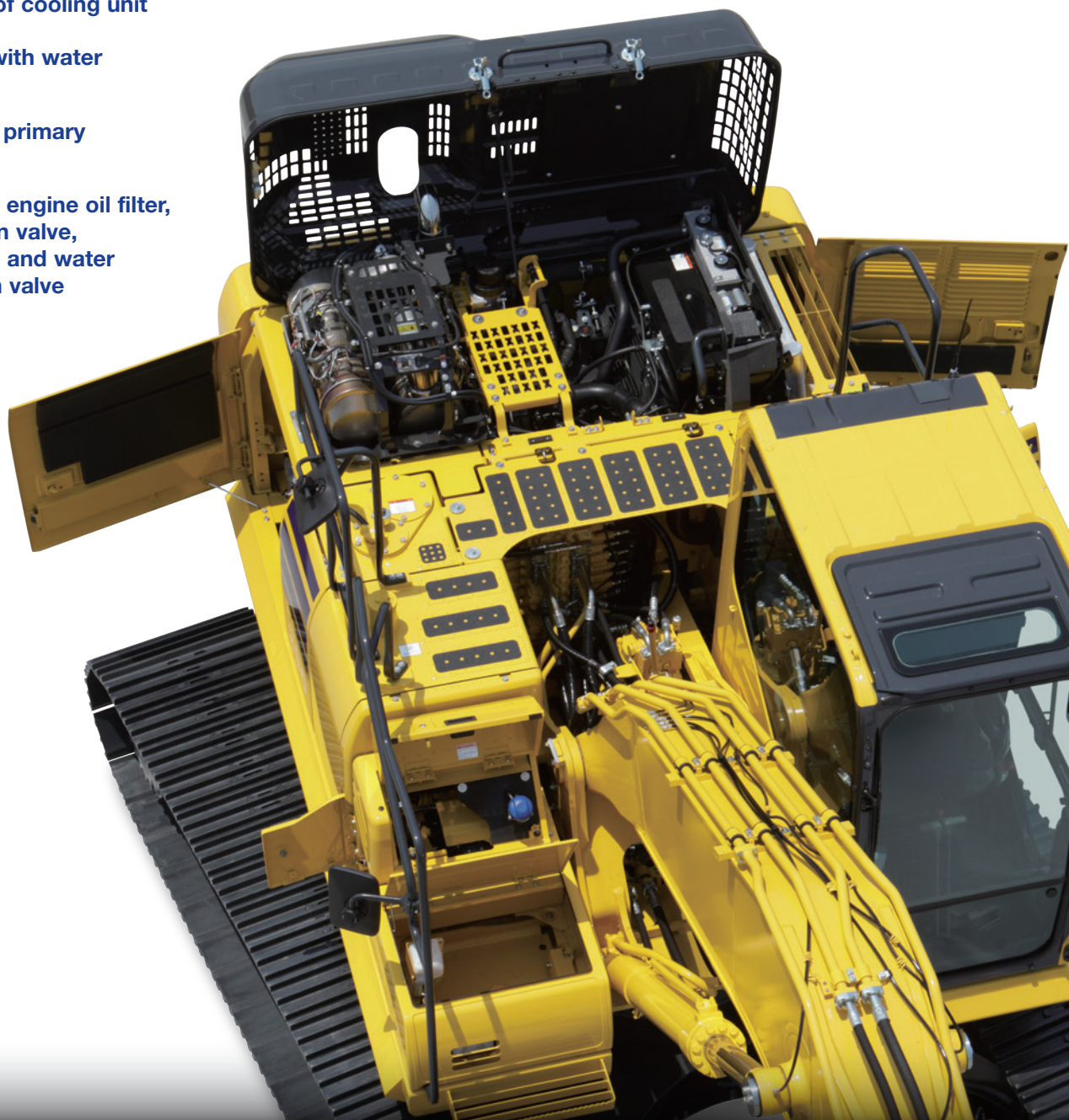

### Long-life oils, filters

High performance filters are used in the hydraulic circuit and engine. By increasing the oil and filter replacement intervals, maintenance costs can be significantly reduced.

Engine oil & Engine oil filter	every 500 hours
Hydraulic oil	every 5000 hours
Hydraulic oil filter	every 1000 hours



Hydraulic oil filter (Ecology white element)

### Large capacity air cleaner

Large capacity air cleaner is comparable to that of larger machines. The larger air cleaner can extend air cleaner life during long-term operation and helps prevent early clogging, and resulting power loss. A radial seal design is used for reliability.

### Diesel Exhaust Fluid (DEF) tank

A large tank volume extends operating time before refilling and is installed on the right front platform for easy access. DEF tank and pump are separated for improved service access.



## Maintenance Information

### “Maintenance time caution lamp” display

When the remaining time to maintenance becomes less than 30 hours\*, a maintenance time monitor appears. Pressing the F6 key switches the monitor to the maintenance screen.

\* : The setting can be changed within the range between 10 and 200 hours.



Maintenance screen

### Manual Stational Regeneration

Under most conditions, active regeneration will occur automatically with no effect on machine operation. In case the operator needs to disable active regeneration or initiate a manual stationary regeneration, this can be easily accomplished through the monitor panel. A soot level indicator is displayed to show how much soot is trapped in the KDPF.



Soot level indicator

Aftertreatment device regeneration screen

### Supports the DEF level and refill timing

The DEF level gauge is displayed continuously on the right side of the monitor screen. In addition, when DEF level is low, DEF low level guidance messages appear in pop up displays to inform the operator in real time.



DEF level gauge

DEF low level guidance

### DT-type connectors

Sealed DT-type electrical connectors provide high reliability, water and dust resistance.

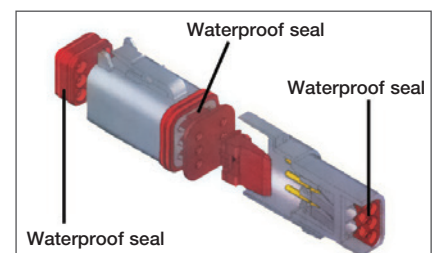

# GENERAL FEATURES

## ROPS CAB STRUCTURE

### ROPS Cab (ISO 12117-2)

The machine is equipped with a ROPS cab that conforms to ISO 12117-2 for excavators as standard equipment. It also satisfies the requirements for Level 1 Operator Protective Guard (OPG) and top guard (ISO 10262).



### Rear View Monitoring System

A new rear view monitoring system display has a rear view camera image that is continuously displayed together with the gauges and important vehicle information. This enables the operator to carry out work while easily checking the surrounding area.

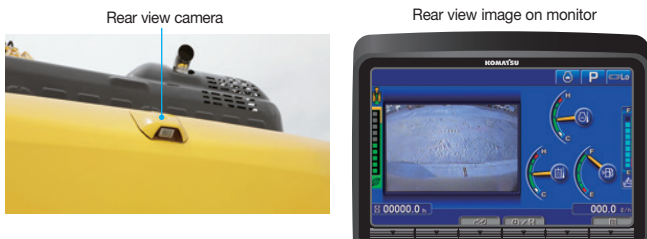

### Low Vibration with Viscous Cab Mounts

The PC240LC-11 uses viscous mounts for the cab that incorporate a longer stroke and the addition of a spring. The cab damper mounting combined with a high rigidity deck reduces vibration at the operator's seat.

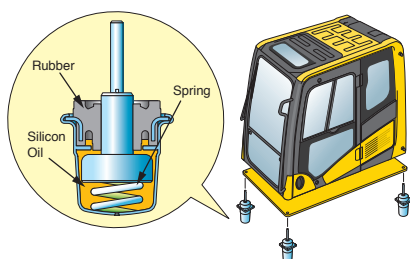

## General Features

**Secondary engine shut down switch** at base of seat to shutdown the engine.



**Left and right side handrails**



**Seat belt caution indicator**



**Lock lever**

**Seat belt retractable**

**Tempered & tinted glass**

**Large mirrors**

**Slip-resistant plates**

**Thermal and fan guards**

**Pump/engine room partition**

**Travel alarm**

**Large cab entrance step**



# KOMTRAX EQUIPMENT MONITORING

GET THE WHOLE STORY WITH  
**KOMTRAX**<sup>®</sup>

## ✓ WHAT

- KOMTRAX is Komatsu's remote equipment monitoring and management system
- KOMTRAX **continuously monitors and records** machine health and operational data
- Information such as fuel consumption, utilization, and a detailed history **lowering owning and operating cost**

## ✓ WHO

- KOMTRAX is **standard** equipment on all Komatsu construction products

## ✓ WHEN

- Know when your machines are **running or idling** and make decisions that will improve your fleet utilization
- Detailed movement records ensure you know when and where your equipment is moved
- Up to date records allow you to **know when maintenance is due** and help you plan for future maintenance needs

## ✓ WHERE

- KOMTRAX data **can be accessed virtually anywhere** through your computer, the web or your smart phone
- Automatic alerts keep fleet managers up to date on the latest machine notifications

## ✓ WHY

- Knowledge is power - **make informed decisions** to manage your fleet better
- Knowing your idle time and fuel consumption will help maximize your machine efficiency
- **Take control of your equipment** - any time, anywhere



**KOMTRAX**<sup>®</sup>

For construction and compact equipment.

**KOMTRAX Plus**<sup>®</sup>

For production and mining class machines.

# KOMATSU PARTS & SERVICE SUPPORT



## KOMATSU CARE

### Program Includes:

\*The PC240LC-11 comes standard with complimentary factory scheduled maintenance for the first 3 Years or 2,000 Hours, whichever comes first.

### Planned Maintenance Intervals at:

500/1000/1500/2000 hour intervals. (250 hr. initial interval for some products) Complimentary Maintenance Interval includes: Replacement of Oils & Fluid Filters with genuine Komatsu Parts, 50-Point inspection, Komatsu Oil & Wear Analysis Sampling (KOWA) / Travel & Mileage (distance set by distributor; additional charges may apply)

### Benefits of Using Komatsu CARE

- Assurance of Proper Maintenance with OEM Parts & Service
- Increased Uptime & Efficiency
- Factory Certified Technicians Performing Work
- Cost of Ownership Savings
- Transferable Upon Resale

### Complimentary KDPF Exchange

The PC240LC-11 comes standard with 2 Complimentary KDPF Exchange Units for the first 5 Years (unlimited hours) Complimentary KDPF Exchange Units are provided at: The suggested KDPF Exchange Units Service Intervals of 4,500 hours and 9,000 hours during the first 5 years. End User must have authorized Komatsu distributor perform the removal and installation of the KDPF.

### Complimentary SCR System Maintenance

The PC240LC-11 also includes 2 factory recommended services of the Selective Catalytic Reduction (SCR) Diesel exhaust fluid (DEF) system during the first 5 years—no hour limit—including: Factory recommended DEF tank flush and strainer cleaning at 4,500 hours and 9,000 hours.

Interval PM	500	1000	1500	2000
KOWA SAMPLING – (Engine, Hydraulics, Swing Circle, L & R Final Drives)	✓	✓	✓	✓
LUBRICATE MACHINE	✓	✓	✓	✓
CHECK SWING PINION GREASE LEVEL AND ADD, WHEN NECESSARY	✓	✓	✓	✓
CHANGE ENGINE OIL	✓	✓	✓	✓
REPLACE ENGINE OIL FILTER	✓	✓	✓	✓
REPLACE FUEL PRE-FILTER	✓	✓	✓	✓
REPLACE AC FRESH & RECIRC AIR FILTERS	✓	✓	✓	✓
CLEAN AIR CLEANER ELEMENT	✓	✓	✓	✓
DRAIN SEDIMENT FROM FUEL TANK	✓	✓	✓	✓
COMPLETE 50 POINT INSPECTION FORM; LEAVE PINK COPY WITH CUSTOMER OR IN CAB	✓	✓	✓	✓
RESET MONITOR PANEL MAINTENANCE COUNTER FOR APPROPRIATE ITEMS	✓	✓	✓	✓
REPLACE HYDRAULIC TANK BREATHER ELEMENT		✓		✓
REPLACE DEF TANK BREATHER		✓		✓
CHECK DAMPER CASE OIL LEVEL, ADD WHEN NECESSARY		✓		✓
REPLACE FUEL MAIN FILTER		✓		✓
REPLACE HYDRAULIC OIL FILTER ELEMENT		✓		✓
CHANGE SWING MACHINERY OIL		✓		✓
CHANGE FINAL DRIVE OIL				✓
CLEAN HYDRAULIC TANK STRAINER				✓
REPLACE DEF PUMP FILTER				✓
REPLACE KCCV FILTER ELEMENT				✓
FACTORY TRAINED TECHNICIAN LABOR	✓	✓	✓	✓
2 KDPF Exchanges at 4,500 Hrs and 9,000 Hrs.				
2 SCR System Maintenance Services at 4,500 Hrs. and 9000 Hrs.				

## Komatsu CARE® – Extended Coverage

- Extended Coverage can provide peace of mind by protecting customers from unplanned expenses that effect cash flow
- Purchasing extended coverage locks-in the cost of covered parts and labor for the coverage period and helps turn these into fixed costs



## Komatsu Parts Support

- 24/7/365 to fulfill your parts needs
- 9 parts Distribution Centers strategically located across the U.S. and Canada
- Distributor network of more than 300 locations across U.S. and Canada to serve you
- Online part ordering through Komatsu eParts
- Remanufactured components with same-as-new warranties at a significant cost reduction



## Komatsu Oil and Wear Analysis (KOWA)

- KOWA detects fuel dilution, coolant leaks, and measures wear metals
- Proactively maintain your equipment
- Maximize availability and performance
- Can identify potential problems before they lead to major repairs
- Reduce life cycle cost by extending component life

\* Certain exclusions and limitations apply. Refer to the customer certificate for complete program details and eligibility. Komatsu® and Komatsu Care® are registered trademarks of Komatsu Ltd. Copyright 2017 Komatsu America Corp.

PC240LC-11

# SPECIFICATIONS



## ENGINE

Model..... Komatsu SAA6D107E-3\*  
 Type ..... Water-cooled, 4-cycle, direct injection  
 Aspiration..... Turbocharged, aftercooled, cooled EGR  
 Number of cylinders..... 6  
 Bore ..... 107 mm **4.21"**  
 Stroke ..... 124 mm **4.88"**  
 Piston displacement.....6.69 ltr **408 in<sup>3</sup>**  
 Horsepower:  
 SAE J1995.....Gross 141 kW **189 HP**  
 ISO 9249 / SAE J1349 .....Net 132 kW **177 HP**  
 Rated rpm..... 2000  
 Fan drive method for radiator cooling ..... Mechanical  
 Governor ..... All-speed control, electronic  
 \*EPA Tier 4 Final emissions certified



## HYDRAULICS

Type ..... HydraMind (Hydraulic Mechanical Intelligence) system, closed-center system with load sensing valves and pressure compensated valves  
 Number of selectable working modes ..... 6  
 Main pump:  
 Type.....Variable displacement piston type  
 Pumps for.....Boom, arm, bucket, swing, and travel circuits  
 Maximum flow ..... 475 ltr/min **125.5 gal/min**  
 Supply for control circuit..... Self-reducing valve  
 Hydraulic motors:  
 Travel..... 2 x axial piston motors with parking brake  
 Swing ..... 1 x axial piston motor with swing holding brake  
 Relief valve setting:  
 Implement circuits ..... 37.3 MPa 380 kg/cm<sup>2</sup> **5,400 psi**  
 Travel circuit..... 37.3 MPa 380 kg/cm<sup>2</sup> **5,400 psi**  
 Swing circuit..... 28.9 MPa 295 kg/cm<sup>2</sup> **4,190 psi**  
 Pilot circuit..... 3.2 MPa 33 kg/cm<sup>2</sup> **470 psi**  
 Hydraulic cylinders:  
 (Number of cylinders – bore x stroke x rod diameter)  
 Boom . 2–135 mm x 1335 mm x 95 mm **5.3" x 52.6" x 3.7"**  
 Arm ... 1–140 mm x 1635 mm x 100 mm **5.5" x 64.4" x 3.9"**  
 Bucket..1–130 mm x 1020 mm x 90 mm **5.1" x 40.2" x 3.5"**



## DRIVES AND BRAKES

Steering control.....Two levers with pedals  
 Drive method ..... Hydrostatic  
 Maximum drawbar pull ..... 202 kN 20570 kg **45,349 lb**  
 Gradeability.....70%, 35°  
 Maximum travel speed: High..... 5.5 km/h **3.4 mph**  
 (Auto-Shift) Mid ..... 4.1 km/h **2.5 mph**  
 (Auto-Shift) Low ..... 3.0 km/h **1.9 mph**  
 Service brake..... Hydraulic lock  
 Parking brake.....Mechanical disc brake



## SWING SYSTEM

Drive method ..... Hydrostatic  
 Swing reduction..... Planetary gear  
 Swing circle lubrication ..... Grease-bathed  
 Service brake..... Hydraulic lock  
 Holding brake/Swing lock..... Mechanical disc brake  
 Swing speed ..... 11.7 rpm  
 Swing torque..... 8065 kg•m **58,334 ft lbs**



## UNDERCARRIAGE

Center frame ..... X-frame  
 Track frame ..... Box-section  
 Seal of track..... Sealed track  
 Track adjuster ..... Hydraulic  
 Number of shoes (each side) ..... 51  
 Number of carrier rollers (each side) ..... 2  
 Number of track rollers (each side) ..... 10



## COOLANT & LUBRICANT CAPACITY (REFILLING)

Fuel tank ..... 400 ltr **105.7 U.S. gal**  
 Coolant ..... 36 ltr **9.5 U.S. gal**  
 Engine..... 23.1 ltr **6.1 U.S. gal**  
 Final drive, each side..... 5.0 ltr **1.3 U.S. gal**  
 Swing drive ..... 7.2 ltr **1.9 U.S. gal**  
 Hydraulic tank..... 132 ltr **34.9 U.S. gal**  
 Hydraulic system..... 244 ltr **64.4 U.S. gal**  
 DEF tank ..... 23.1 ltr **6.1 U.S. gal**



## SOUND PERFORMANCE

Exterior – ISO 6395.....103 dB(A)  
 Operator – ISO 6396.....70 dB(A)



## OPERATING WEIGHT (APPROXIMATE)

Operating weight includes 5850 mm **19'2"** one-piece boom, 3045 mm **10'0"** arm, SAE heaped 1.42 m<sup>3</sup> **1.85 yd<sup>3</sup>** bucket, rated capacity of lubricants, coolant, full fuel tank, operator, and standard equipment.

Triple-Grouser Shoes	Operating Weight	Ground Pressure ISO 16754
700 mm <b>28"</b>	25294 kg <b>55,763 lb</b>	0.44 kg/cm <sup>2</sup> <b>6.23 psi</b>
800 mm <b>31.5"</b>	25574 kg <b>56,380 lb</b>	0.39 kg/cm <sup>2</sup> <b>5.51 psi</b>

## Component Weights

Arm including bucket cylinder and linkage  
 3045 mm **10'0"** arm assembly ..... 1222 kg **2,694 lb**  
 3046 mm **10'0"** HD arm assembly ..... 1318 kg **2,906 lb**  
 3500 mm **11'6"** arm assembly ..... 1442 kg **3,179 lb**  
 One piece boom including arm cylinder  
 6150 mm **20'2"** boom assembly ..... 2219 kg **4,892 lb**  
 6150 mm **20'2"** boom assembly ..... 2325 kg **5,126 lb**  
 Boom cylinders x 2 ..... 210 kg **463 lb**  
 Counterweight ..... 4670 kg **10,296 lb**  
 1.42 m<sup>3</sup> **1.85 yd<sup>3</sup>** bucket - 48" width ..... 1088 kg **2,400 lb**

# SPECIFICATIONS



## DIMENSIONS

	Arm Length	3045 mm	10'0"	3500 mm	11'6"
A	Overall length	9965 mm	32'8"	9990	32'9"
B	Length on ground (transport)	5390 mm	17'8"	4950	16'3"
C	Overall height (to top of boom)*	3185 mm	10'5"	3270	10'9"
D	Overall width	3280 mm	10'9"		
E	Overall height (to top of cab)*	3055 mm	10'0"		
F	Overall height (to top of handrail)*	3150 mm	10'4"		
G	Ground clearance, counterweight	1100 mm	3'7"		
H	Ground clearance, minimum	440 mm	1'5"		
I	Tail swing radius	3020 mm	9'11"		
J	Track length on ground	3845 mm	12'7"		
K	Track length	4640 mm	15'3"		
L	Track gauge	2580 mm	8'6"		
M	Width of crawler	3280 mm	10'9"		
N	Shoe width	700 mm	2'4"		
O	Grouser height	26 mm	0'1"		
P	Machine height to top of counterweight	2265 mm	7'5"		
Q	Machine height to top of engine cover	2780 mm	9'1"		
R	Machine upper width	2850 mm	9'4"		
S	Distance, swing center to rear end	2985 mm	9'10"		

\* : Including grouser height

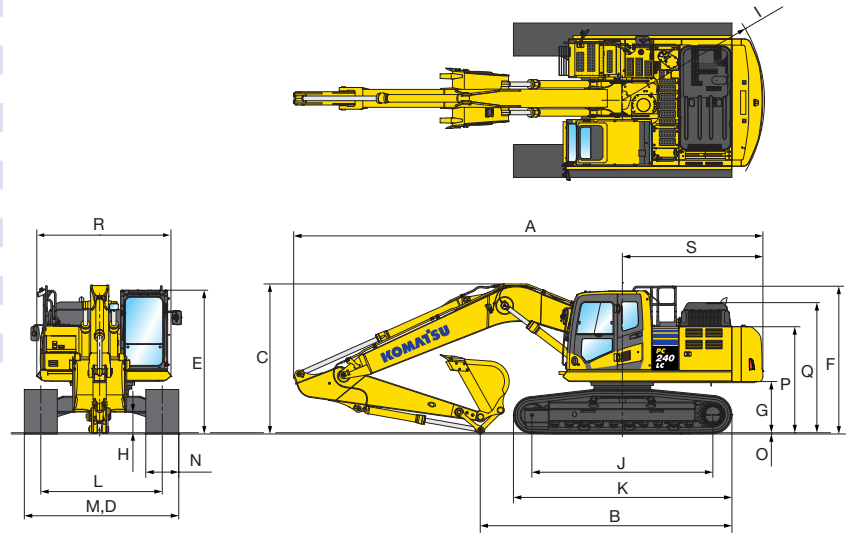

## BACKHOE BUCKET, ARM AND BOOM COMBINATION

Bucket Type	Bucket				5.85 m (29'2") Boom			
	Capacity	Width		Weight	3.0 m (10'0")	3.5 m (11'6")		
Komatsu TL	0.58 m <sup>3</sup>	0.76 yd <sup>3</sup>	610 mm	24"	687 kg	1514 lb	●	●
	0.78 m <sup>3</sup>	1.02 yd <sup>3</sup>	762 mm	30"	807 kg	1779 lb	●	●
	0.99 m <sup>3</sup>	1.29 yd <sup>3</sup>	914 mm	36"	907 kg	2000 lb	●	●
	1.20 m <sup>3</sup>	1.57 yd <sup>3</sup>	1067 mm	42"	949 kg	2178 lb	○	○
	1.41 m <sup>3</sup>	1.85 yd <sup>3</sup>	1219 mm	48"	1045 kg	2399 lb	□	□
Komatsu HP	0.58 m <sup>3</sup>	0.76 yd <sup>3</sup>	610 mm	24"	812 kg	1791 lb	●	●
	0.78 m <sup>3</sup>	1.02 yd <sup>3</sup>	762 mm	30"	931 kg	2053 lb	●	●
	0.99 m <sup>3</sup>	1.29 yd <sup>3</sup>	914 mm	36"	1054 kg	2323 lb	●	●
	1.20 m <sup>3</sup>	1.57 yd <sup>3</sup>	1067 mm	42"	1154 kg	2545 lb	○	□
	1.41 m <sup>3</sup>	1.85 yd <sup>3</sup>	1219 mm	48"	1278 kg	2817 lb	□	○
Komatsu HPS	0.58 m <sup>3</sup>	0.76 yd <sup>3</sup>	610 mm	24"	870 kg	1917 lb	●	●
	0.78 m <sup>3</sup>	1.02 yd <sup>3</sup>	762 mm	30"	1020 kg	2248 lb	●	●
	0.99 m <sup>3</sup>	1.29 yd <sup>3</sup>	914 mm	36"	1162 kg	2562 lb	●	●
	1.20 m <sup>3</sup>	1.57 yd <sup>3</sup>	1067 mm	42"	1282 kg	2827 lb	○	□
	1.41 m <sup>3</sup>	1.85 yd <sup>3</sup>	1219 mm	48"	1425 kg	3142 lb	○	○
Komatsu HPX	0.58 m <sup>3</sup>	0.76 yd <sup>3</sup>	610 mm	24"	987 kg	2177 lb	●	●
	0.78 m <sup>3</sup>	1.02 yd <sup>3</sup>	762 mm	30"	1138 kg	2508 lb	●	●
	0.99 m <sup>3</sup>	1.29 yd <sup>3</sup>	914 mm	36"	1280 kg	2822 lb	●	○
	1.20 m <sup>3</sup>	1.57 yd <sup>3</sup>	1067 mm	42"	1400 kg	3087 lb	□	□
	1.41 m <sup>3</sup>	1.85 yd <sup>3</sup>	1219 mm	48"	1543 kg	3402 lb	○	○

● - Used with material weights up to 3,500 lb/yd<sup>3</sup> - Quarry/rock/high abrasion applications  
 □ - Used with material weights up to 2,500 lb/yd<sup>3</sup> - General construction

○ - Used with material weights up to 3,000 lb/yd<sup>3</sup> - Tough digging applications  
 ○ - Used with material weights up to 2,000 lb/yd<sup>3</sup> - Light materials applications  
 X - Not useable





WORKING RANGE

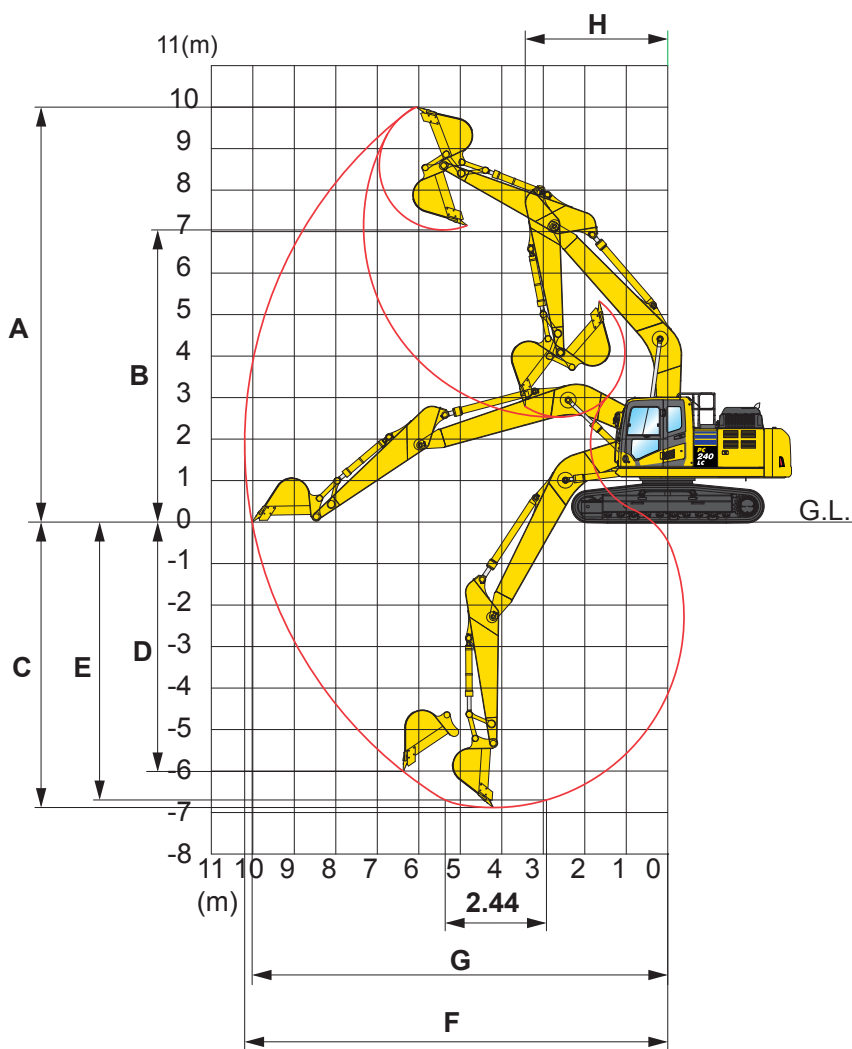

	Arm Length	3045 mm	10'0"	3500 mm	11'6"
<b>A</b>	Max. digging height	10000 mm	32'10"	10300 mm	33'10"
<b>B</b>	Max. dumping height	7035 mm	23'1"	7360 mm	24'2"
<b>C</b>	Max. digging depth	6920 mm	22'8"	7320 mm	24'0"
<b>D</b>	Max. vertical wall digging depth	6010 mm	19'9"	6230 mm	20'5"
<b>E</b>	Max. digging depth for 8' level bottom	6700 mm	22' 0"	7150 mm	23'5"
<b>F</b>	Max. digging reach	10180 mm	33'5"	10580 mm	34'9"
<b>G</b>	Max. digging reach at ground level	10020 mm	32'10"	10420 mm	34'2"
<b>H</b>	Min. swing radius	3450 mm	11'4"	3340 mm	10'11"
<b>SAE rating</b>	Bucket digging force at power max.	152 kN		152 kN	
		15500 kg / 34,171 lb		15500 kg / 34,171 lb	
<b>ISO rating</b>	Arm crowd force at power max.	119 kN		107 kN	
		12100 kg / 26,752 lb		10900 kg / 24,055 lb	
<b>SAE rating</b>	Bucket digging force at power max.	172 kN		172 kN	
		17500 kg / 38,667 lb		17500 kg / 38,667 lb	
<b>ISO rating</b>	Arm crowd force at power max.	129 kN		110 kN	
		13200 kg / 29,000 lb		11200 kg / 24,729 lb	

# LIFT CAPACITIES



## LIFTING CAPACITY WITH LIFTING MODE

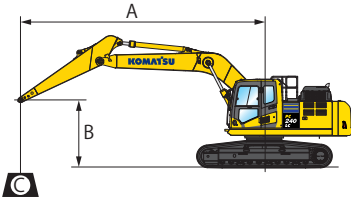

- A: Reach from swing center
- B: Bucket hook height
- C: Lifting capacity
- Cf: Rating over front
- Cs: Rating over side
- ⊗: Rating at maximum reach

Conditions:

- Boom length: 5850 mm 19' 2" one-piece boom
- Bucket: None
- Lifting mode: On

Arm: 3045 mm 10'0"		Bucket: None				Shoes: 700 mm 28" triple arouser				Unit: kg lb			
B	A MAX	1.5 m 5'		3.0 m 10'		4.6 m 15'		6.1 m 20'		7.6 m 25'		⊗ MAX	
		Cf	Cs	Cf	Cs	Cf	Cs	Cf	Cs	Cf	Cs	Cf	Cs
7.6 m 25'	6.5 m 21'							* 5950	* 5950			* 4700	* 4700
								* 13200	* 13200			* 10400	* 10400
6.1 m 20'	7.5 m 25'							* 6400	* 6400			* 4450	* 4450
								* 14100	* 14100			* 9800	* 9800
4.6 m 15'	8.2 m 27'			* 8050	* 8050	* 7200	6900	* 6900	4950	* 4450	4400		
				* 17700	* 17700	* 15900	15200	* 15200	10900	* 9800	9700		
3.0 m 10'	8.6 m 28'			* 10700	10000	* 8450	6600	6950	4800	* 4600	4050		
				* 23600	22000	* 18700	14600	15400	10600	* 10100	8900		
1.5 m 5'	8.6 m 28'			* 13200	9400	9450	6350	6800	4650	* 4900	3950		
				* 29100	20800	20900	14000	15000	10300	* 10800	8700		
0 m 0'	8.4 m 28'		* 7850	* 7850	14600	9100	9250	6150	6700	4550	* 5450	4000	
			* 17300	* 17300	32200	20100	20400	13500	14600	10100	* 12100	8800	
-1.5 m -5'	7.9 m 26'	* 8250	* 8250	* 12850	* 12850	14500	9000	9150	6050	6650	4500	6300	4300
		* 18200	* 18200	* 28400	* 28400	32000	19800	20200	13300	14700	10000	13900	9500
-3.0 m -10'	7.1 m 23'	* 13450	* 13450	* 19750	17650	14550	9050	9150	6050			7450	5050
		* 29700	* 29700	* 43600	38900	32100	19900	20200	13400			16400	11100
-4.6 m -15'	5.7 m 19'			* 17750	* 17750	12600	9250					* 9800	6900
				* 39100	* 39100	27700	20400					* 21700	15200

\*Load is limited by hydraulic capacity rather than tipping. Ratings are based on ISO standard No. 10567. Rated loads do not exceed 87% of hydraulic lift capacity or 75% of tipping load.



## LIFTING CAPACITY WITH LIFTING MODE

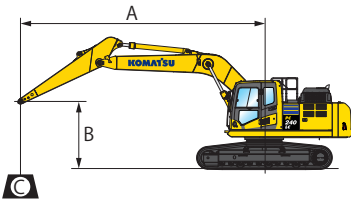

- A: Reach from swing center
- B: Bucket hook height
- C: Lifting capacity
- Cf: Rating over front
- Cs: Rating over side
- ⊗: Rating at maximum reach

Conditions:

- Boom length: 5850 mm 19' 2" one-piece boom
- Bucket: None
- Lifting mode: On

Arm: 3045 mm 10'0"		Bucket: None				Shoes: 800 mm 31.5" triple grouser				Unit: kg lb			
B	A MAX	1.5 m 5'		3.0 m 10'		4.6 m 15'		6.1 m 20'		7.6 m 25'		⊗ MAX	
		Cf	Cs	Cf	Cs	Cf	Cs	Cf	Cs	Cf	Cs	Cf	Cs
7.6 m 25'	7.0 m 23'							* 5950	* 5950			* 4700	* 4700
								* 13200	* 13200			* 10400	* 10400
6.1 m 20'	8.0 m 26'							* 6400	* 6400			* 4450	* 4450
								* 14100	* 14100			* 9800	* 9800
4.6 m 15'	8.6 m 28'			* 8050	* 8050	* 7200	6950	* 6900	5000	* 4450	4400		
				* 17700	* 17700	* 15900	15300	* 15200	11000	* 9800	9800		
3.0 m 10'	9.0 m 29'			* 10700	10100	* 8450	6650	7050	4850	* 4600	4100		
				* 23600	22200	* 18700	14700	15500	10700	* 10100	9000		
1.5 m 5'	9.0 m 30'			* 13200	9500	9550	6400	6900	4700	* 4900	3950		
				* 29100	21000	21100	14100	15200	10400	* 10800	8800		
0 m 0'	8.8 m 29'		* 7850	* 7850	14700	9200	9350	6200	6750	4600	* 5450	4050	
			* 17300	* 17300	32400	20300	20600	13700	14900	10200	* 12100	8900	
-1.5 m -5'	8.3 m 27'	* 8250	* 8250	* 12850	* 12850	14650	9100	9250	6100	6750	4550	6400	4350
		* 18200	* 18200	* 28400	* 28400	32300	20000	20400	13500	14800	10100	14100	9600
-3.0 m -10'	7.5 m 25'	* 13450	* 13450	* 19750	17850	* 14550	9150	9250	6100			7550	5100
		* 29700	* 29700	* 43600	39300	* 32100	20100	20400	13500			16600	11200
-4.6 m -15'	6.2 m 20'			* 17750	* 17750	12600	9350					* 9800	6950
				* 39100	* 39100	27700	20600					* 21700	15400

\*Load is limited by hydraulic capacity rather than tipping. Ratings are based on ISO standard No. 10567. Rated loads do not exceed 87% of hydraulic lift capacity or 75% of tipping load.



## LIFTING CAPACITY WITH LIFTING MODE

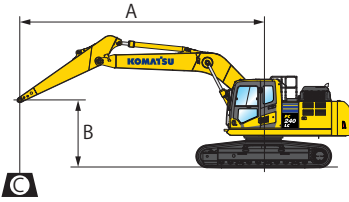

- A: Reach from swing center
- B: Bucket hook height
- C: Lifting capacity
- Cf: Rating over front
- Cs: Rating over side
- ⊗: Rating at maximum reach

Conditions:

- Boom length: 5850 mm 19' 2" one-piece boom
- Bucket: None
- Lifting mode: On

Arm: 3500 mm 11'6"		Bucket: None				Shoes: 700 mm 28" triple grouser				Unit: kg lb			
B	A	1.5 m 5'		3.0 m 10'		4.6 m 15'		6.1 m 20'		7.6 m 25'		⊗ MAX	
	MAX	Cf	Cs	Cf	Cs	Cf	Cs	Cf	Cs	Cf	Cs	Cf	Cs
7.6 m 25'	7.0 m 23'							* 5500	* 5500			* 4000	* 4000
								* 12100	* 12100			* 8800	* 8800
6.1 m 20'	8.0 m 26'							* 5650	* 5650	* 5100	4950	* 3850	* 3850
								* 12500	* 12500	* 11200	10900	* 8400	* 8400
4.6 m 15'	8.6 m 28'							* 6500	* 6500	* 6300	4850	* 3800	* 3800
								* 14300	* 14300	* 13900	10700	* 8400	* 8400
3.0 m 10'	9.0 m 29'			* 14650	* 14650	* 9600	* 9600	* 7750	6550	6900	4700	* 3950	3700
				* 32300	* 32300	* 21100	* 21100	* 17100	14400	15200	10400	* 8700	8100
1.5 m 5'	9.0 m 30'					* 12200	9300	* 9150	6200	6700	4550	* 4200	3550
						* 27000	20500	* 20200	13700	14800	10000	* 9300	7900
0 m 0'	8.8 m 29'			* 8750	* 8750	* 14000	8850	9050	5950	6550	4400	* 4650	3600
				* 19300	* 19300	* 30900	19500	20000	13100	14400	9700	* 10300	8000
-1.5 m -5'	8.3 m 27'	* 7800	* 7800	* 12400	* 12400	14150	8700	8900	5800	6450	4350	* 5450	3850
		* 17200	* 17200	* 27400	* 27400	31200	19100	19700	12800	14300	9600	* 12000	8500
-3.0 m -10'	7.5 m 25'	* 12050	* 12050	* 17850	17050	14200	8700	8900	5800			6600	4450
		* 26600	* 26600	* 39400	37500	31300	19200	19700	12800			14600	9800
-4.6 m -15'	6.2 m 20'			* 18750	17450	* 13100	8900	9100	5950			8800	5800
				* 41300	38500	* 28900	19600	20100	13200			19400	12800

\*Load is limited by hydraulic capacity rather than tipping. Ratings are based on ISO standard No. 10567. Rated loads do not exceed 87% of hydraulic lift capacity or 75% of tipping load.



## LIFTING CAPACITY WITH LIFTING MODE

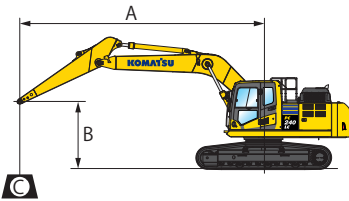

- A: Reach from swing center
- B: Bucket hook height
- C: Lifting capacity
- Cf: Rating over front
- Cs: Rating over side
- ⊗: Rating at maximum reach

Conditions:

- Boom length: 5850 mm 19' 2" one-piece boom
- Bucket: None
- Lifting mode: On

Arm: 3500 mm 11'6"		Bucket: None				Shoes: 800 mm 31.5" triple grouser				Unit: kg lb			
B	A	1.5 m 5'		3.0 m 10'		4.6 m 15'		6.1 m 20'		7.6 m 25'		⊗ MAX	
	MAX	Cf	Cs	Cf	Cs	Cf	Cs	Cf	Cs	Cf	Cs	Cf	Cs
7.6 m 25'	7.0 m 23'							* 5500	* 5500			* 4000	* 4000
								* 12100	* 12100			* 8800	* 8800
6.1 m 20'	8.0 m 26'							* 5650	* 5650	* 5100	5000	* 3850	* 3850
								* 12500	* 12500	* 11200	11000	* 8400	* 8400
4.6 m 15'	8.6 m 28'							* 6500	* 6500	* 6300	4900	* 3800	* 3800
								* 14300	* 14300	* 13900	10800	* 8400	* 8400
3.0 m 10'	9.0 m 29'			* 14650	* 14650	* 9600	* 9600	* 7750	6600	* 6950	4750	* 3950	3700
				* 32300	* 32300	* 21100	* 21100	* 17100	14500	* 15300	10500	* 8700	8200
1.5 m 5'	9.0 m 30'					* 12200	9400	* 9150	6250	6750	4600	* 4200	3600
						* 27000	20700	* 20200	13800	14900	10100	* 9300	7900
0 m 0'	8.8 m 29'			* 8750	* 8750	* 14000	8950	9150	6000	6600	4450	* 4650	3650
				* 19300	* 19300	* 30900	19700	20200	13300	14600	9800	* 10300	8100
-1.5 m -5'	8.3 m 27'	* 7800	* 7800	* 12400	* 12400	14300	8800	9000	5900	6550	4400	* 5450	3900
		* 17200	* 17200	* 27400	* 27400	31600	19400	19900	13000	14400	9700	* 12000	8600
-3.0 m -10'	7.5 m 25'	* 12050	* 12050	* 17850	17200	14350	8800	9000	5850			6700	4500
		* 26600	* 26600	* 39400	37900	31600	19400	19900	12900			14700	9900
-4.6 m -15'	6.2 m 20'			* 18750	17600	* 13100	9000	9200	6050			8900	5850
				* 41300	38800	* 28900	19800	20300	13300			19600	12900

\*Load is limited by hydraulic capacity rather than tipping. Ratings are based on ISO standard No. 10567. Rated loads do not exceed 87% of hydraulic lift capacity or 75% of tipping load.



## STANDARD EQUIPMENT

- 3 Speed travel with Auto shift
- Alternator, 90 Ampere, 24V
- AM/FM radio
- Automatic engine warm-up system
- Automatic air conditioner/heater
- Auto idle
- Auto Idle Shutdown (programmable)
- Lever lock Auto-lock
- Auxiliary input (3.5 mm jack)
- Batteries, large capacity
- Battery disconnect switch
- Boom and arm holding valves
- Carrier rollers (2 each side)
- Converter, (2) x 12V
- Counterweight, 4670 kg **10,296 lb**
- Dry type air cleaner, double element
- Electric horn
- EMMS monitoring system
- Engine, Komatsu SAA6D107E-3
- Engine coolant to -25°C **-13°F**
- Extended work equipment grease interval
- Fan guard structure
- Fuel system pre-cleaner 10 micron
- High back air suspension seat, with heat
- Hydraulic track adjusters
- KOMTRAX® Level 5.0
- Large LCD color monitor, high resolution
- Lock lever
- Mirrors, (LH and RH)
- Operator Protective Top Guard (OPG), Level 1 (ISO 10262)
- Operator Identification System
- Pattern change valve (ISO to BH control)
- Power maximizing system
- PPC hydraulic control system
- Pump/engine room partition cover
- Radiator and oil cooler dustproof net
- Rear reflectors
- Rearview monitoring system (1 camera)
- Revolving frame deck guard
- Revolving frame undercovers
- ROPS cab (ISO 12117-2)
- Seat belt, retractable, 76 mm **3"**
- Seat belt indicator
- Secondary engine shutoff switch
- Service valve
- Shoes, triple grouser, 800 mm **31.5"**
- Skylight
- Slip resistant foot plates
- Starter motor, 5.5kW/24V x 1
- Suction fan
- Thermal and fan guards
- Track frame undercover
- Track frame swivel guard
- Travel alarm
- Working lights, 2 (boom and RH front)
- Working mode selection system



## OPTIONAL EQUIPMENT

- Arms
  - 3045 mm **10'0"** arm assembly
  - 3045 mm **10'0"** HD arm assembly with piping
  - 3500 mm **11'6"** arm assembly
  - 3500 mm **11'6"** arm assembly with piping
- Booms
  - 5850 mm **19'2"** boom assembly
  - 5850 mm **19'2"** HD boom assembly with piping
- Cab guards
  - Full front guard, OPG Level 1
  - Full front guard, OPG Level 2
  - Bolt-on top guard, OPG Level 2
  - Lower front window guard
- High pressure in-line hydraulic filters
- Hydraulic control unit, 1 actuator
- Proportional control handles
- Reinforced revolving frame with 5500 kg **12,125 lb** counterweight
- Revolving frame undercovers, heavy duty
- Shoes, triple grouser, 700 mm **28"**
- Sun visor
- Rain visor
- Straight travel pedal
- Track roller guards, full length
- Working light, front, two additional cab mounted



## ATTACHMENT OPTIONS

- Cab air pre-cleaner
- Grade control systems
- Hydraulic couplers
- Hydraulic kits, field installed
- Load hold, anti-burst valves
- Super long fronts
- PSM thumbs
- Rockland thumbs
- Vandalism protection guards with storage box

**For a complete list of available attachments, please contact your local Komatsu distributor.**

# KOMATSU®

*Note: All comparisons and claims of improved performance made herein are made with respect to the prior Komatsu model unless otherwise specifically stated.*