

Loading tool selection guide



We're here to help you **be successful**



In today's mining business, you're under tremendous pressure to increase production and reduce costs. So you're constantly looking for ways to optimize equipment for your specific operation and objectives.

Choosing the right equipment is daunting: it is a major expense and there are so many companies and options and technologies to choose from. Plus, you have to consider your mine layout, geologic conditions, blasting techniques, on-site maintenance capabilities, and capital recovery.

As a partner to mining companies around the world, we are here to help.

We created this loading tool selection guide to:

- Make selecting loading tools for a loading and haulage surface mining operation easier and simpler
- Give you the relevant and technical information you need to prepare for a purchasing decision in one place
- Provide you with guidance and insight on the type of loading tools that may be best for your operation, based on typical mining conditions and environments
- Evaluate which Komatsu machines could have a significant impact on your productivity

Overall, this guide compiles key equipment criteria to simplify and enhance your surface mining loading tool selection process.

Why trust Komatsu?

1. As a leading global distributor of shovels, hydraulic excavators, wheel loaders, trucks, drills, dozers, draglines, conveyors, and other mining equipment, **we understand the issues involved in selecting mining equipment.**
2. Offering the widest range of surface mining loading equipment on the market, **we have deep insights into how all this equipment works together to maximize productivity.**
3. You can count on us to keep your fleet producing at its highest level, as we provide **logistics and a full range of life cycle management service support expertise.**
4. When you need service or parts, you can count on us, as we've established **a global network of service centers strategically located in mining regions.**
5. More than a vendor, we function as a trusted partner. We strive to leverage our expertise in the industry to offer you **comprehensive solutions.**
6. We are focused on harnessing the power of industrial technology to **support a sustainable, prosperous future** for all, including a top priority of creating a **culture of zero harm.**



Loading tool selection guide

How to use this guide

Selecting loading tools for a loading and haulage surface mining operation is a complex process. This guide is a comprehensive first step.

We cover the types of loaders, how they get the job done and their advantages and disadvantages, especially in different mining conditions. There are also insights into mine design, productivity and costs, all informed by our more than 100 years of mining experience and the latest data.

By reviewing this guide and applying its insights to your specific needs, you'll have a solid direction for your purchasing decisions. The next step is to contact your Komatsu loading tool expert, who can then collaborate with you to determine the specific options for your exact operation, conditions and needs.





Komatsu loading tool product lineup

Our surface mining product categories include:

- **Electric mining shovels** with AC drives
- **Hybrid shovels** with significantly reduced fuel consumption and on-board hydraulics
- **Hydraulic excavators** in front shovel or backhoe configuration; diesel or electric drive
- **Wheel loaders** with mechanical or electric drivetrains

Each of the above products are designed to load mining haul trucks, but are more effective in different conditions and mining designs. Here are a few examples:

- The agile wheel loader is an excellent machine for multiple faces, blending material, and versatility
- Electric mining shovels are the most productive and cost-effective loading tool for long-life mines — even though they have the highest capital cost
- Hydraulic excavators and hybrid shovels are a practical fit between wheel loaders and electric mining shovels — delivering mobility, flexibility and high productivity



Did you know?

95%

Trucks and loaders are used in approximately 95 percent of surfacing mining operations, due to their combination of reliability, performance and lower costs (achieved through economies of scale).

Electric rope shovels: overview

An electric mining shovel, often referred to as a mining rope shovel or an electric rope shovel, is designed specifically to dig and load material in surface mines. The electric mining shovel uses electric motors, gear reducers, drums, and wire rope to actuate the digging, loading, and propelling motions. The capacity of these machines is typically 10 m³ (14 yds³) to more than 69+ m³ (90+ yds³) for standard rock applications.

P&H electric rope shovels

P&H electric rope shovels have the longest machine life in the industry and designed to keep operations working 24/7. In fact, our P&H electric rope shovels consistently achieve mechanical availability of 90% or more. They are also equipped with a long list of productivity-boosting features.

General information:

- Design life of 120,000 hours (~20 years)
- Electric infrastructure required
- Tracked machine means less mobility than wheel loaders

Key production factors:

- Capable of largest dipper payloads (up to 122 mt)
- Higher production rates realized through electrical architecture (reliability and electric motor performance)
- Long reach enables double-side loading
- Limited digging selectivity

Cost considerations:

- High capital cost
- Lowest cost-per-ton for long-life mines
- Fixed boom means limited energy required during loading cycle

P&H 1900

Nominal payload: 18 mt (20 st)
Nominal dipper capacity:
10.7 m³ (14 yd³)



P&H 2300

Nominal payload: 45.4 mt (50 st)
Nominal dipper capacity:
18.3 - 25.5 m³ (24.0 to 33.0 yd.³)



P&H 2800

Nominal payload: 59 mt (65 st)
Nominal dipper capacity:
26.8 to 33.6 m³ (35.0 to 44.0 yd.³)



The impact of just 1% loading efficiency improvement

1%

A study of surface mining efficiency using a rope shovel found that a one percent increase in loading efficiency translated into savings of \$1 million U.S. dollars. That makes responsive controls, a comfortable cabin and real-time access to equipment health information vital – all features integrated into P&H rope shovels. Plus, we offer immersive simulation training for your operators.



Pros and cons: electric rope shovel

Pros

- Lowest cost-per-ton
- Low energy and operating costs
- 20+ year machine design life
- Most efficient digging height (safely digging with bench height to boom point sheaves)
- Ground pressure distribution tailored to site requirements
- Lowest greenhouse emissions (more environmentally friendly)
- Large dippers and payloads enable bulk mining capabilities
- Right hand cab prevents double blind loading; long reach enables efficient double side loading
- High availability and reliability
- Fewer maintenance requirements

Cons

- High capital cost
- Mobility (restricted by electrical grid)
- Clean-up support
- Limited selectivity, as the dig phase needs at start bench floor (must return to tuck)

P&H 4100XPC AC-90

Nominal payload: 73 to 82 mt (80 to 90 st)
 Nominal dipper capacity: 42 to 49 m³ (54 to 64 yd.³)



P&H 4100C BOSS

Nominal payload: 90.7 mt (100 st)
 Nominal dipper capacity: 49.0 m³ (64.0 yd.³)

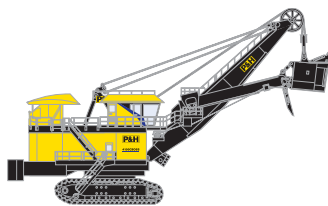

P&H 4100XPC

Nominal payload: 108.9 mt (120 st)
 Nominal dipper capacity: 52.8 to 61.2 m³ (69 to 82 yd.³)

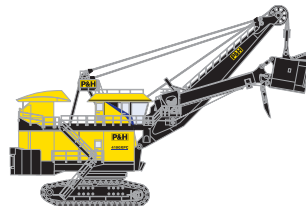

P&H 4800

Nominal payload: 122.5 mt (135 st)
 Nominal dipper capacity: 65.7 to 70.3 m³ (86 to 92 yd.³)



Hydraulic mining excavators

With hydraulic mining excavators, hydraulic pumps, motors, and cylinders – powered by diesel or electric motors – actuate digging, loading and propulsion. The capacity of these machines in mining operations is typically 12 m³ (15 yd³) to 50 m³ (65yd³) for standard rock applications.

General information:

- Hydraulic mining excavators can be configured as front shovels or backhoes
- Hydraulic backhoes can achieve the highest production when positioned on an upper bench while loading haul trucks on a lower level
- Hydraulic front shovels can be used to operate in tight digging conditions
- AC drive offers lower cost-per-ton for electrified mines
- As the reach is less than electric rope shovels, proper truck match is important – particularly when operating in double-sided loading conditions.
- Hydraulic front shovels offer greater mobility than rope shovels and are suitable for most floor conditions

Komatsu hydraulic mining excavators

Komatsu hydraulic mining excavators produce fast cycle times, effortless multifunction motions, precise bucket movements, and excellent lifting capabilities. Choose from a range of hydraulic excavators in front shovel or backhoe configurations to fit your optimum loading capacity. The estimated life span for Komatsu hydraulic shovels is greater than ten years.

PC2000

Bucket size: 12m³
Weight: 200 tons
Truck match: 90-160 tons



PC3000

Bucket size: 16m³
Weight: 257-264 tons
Truck match: 85-165 tons



PC4000

Bucket size: 22m³
Weight: 398-409 tons
Truck match: 150-240 tons





Did you know?

The Komatsu PC8000-6 has an operating weight of up to 752 tons, making it the fifth largest hydraulic mining excavator. The Komatsu PC5500 has an operating weight of 495 tons, which makes it the ninth biggest mining excavator in the world.

Pros and cons: hydraulic front shovel excavators

Pros

- Tight loading materials
- Tight loading area
- Selective digging
- Excellent ground pressure distribution
- Fine for soft floors
- Fine for uneven floors

Cons

- Excessive tramming
- Clean-up support
- Low face
- Multiple faces

Pros and cons: hydraulic backhoe excavators

Pros

- Single loading face
- Tight digging materials
- Excellent ground pressure distribution
- Face height to stick length
- Short swings
- High production

Cons

- Clean-up support
- Low angle of repose
- Unstable benches
- Excessive tramming
- Requires high benches

PC5500

Bucket size: 29m³
 Weight: 537-556 tons
 Truck match: 150-240 tons



PC7000

Bucket size: 38m³
 Weight: 678-696 tons
 Truck match: 240-290 tons



PC8000

Bucket size: 42m³
 Weight: 769-790 tons
 Truck match: 240-290 tons



Hybrid shovel

Hybrid shovels are a new loading tool developed by Komatsu. In the simplest terms, it can be described as a diesel-powered rope shovel. It uses both electric and hydraulic motors to offer a lower capital cost than rope shovels and a lower operating cost than hydraulic excavators. These innovative workhorses combine the cost-per-ton advantages of electric rope shovels with the mobility and selective digging advantages of hydraulic excavators.

Like rope shovels, hybrid shovels use electric motors, gear reducers, drums, and wire rope to actuate the hoist, crowd, or swing functions of the loading cycle. Like a hydraulic excavator, hybrid shovels use hydraulic power for bucket curl, bucket dump, and propulsion.

A hybrid shovel can be advantageous in many different mining operations, particularly coal, iron ore, copper, and gold. Because it is diesel powered, hybrid shovels can operate in sites without electric grid access, such as greenfield or remote locations. It is a loading alternative to rope shovels or hydraulic excavators.

Komatsu currently offers one hybrid shovel model, the P&H 2650CX and plans to expand the product line. The 2650CX rated payload is 59–64 tonnes (65–70.5 st). Bucket sizes range from 27 m³ (35 yd³) to 39 m³ (51 yd³). It is capable of loading 150–400-ton trucks.

General information:

- Design Life of 90,000 hours (~15 years)
- Diesel-powered
- Tracked machine means similar mobility to hydraulic excavators
- Design combines advantages of rope shovels and hydraulic excavators

Key production factors:

- Clamshell bucket rated for 59–64 mt (65–70.5 st)
- Higher production rates realized through higher production rates realized through electrical architecture (reliability and electric motor performance)
- Longer reach than hydraulic excavators allows for double-side loading
- Selective digging capability
- Multiple digging paths

Cost considerations:

- Capital cost generally between rope shovel and hydraulic excavator
- Lowest cost-per-ton for diesel-powered machine
- Fixed boom means less energy required during loading cycle
- SR technology (see next page) provides ability to regenerate power

Tech spotlight: SR Hybrid Drive

The P&H 2650CX features an innovative SR Hybrid Drive system to save fuel and enhance performance. During braking, the SR motors become generators. The power generated is transferred back to a shared DC bus. Power not consumed by other motors is transferred to the generators which back drive the diesel engines, ultimately shutting off or significantly reducing fuel supply.



Innovative hybrid power for the future of mining

P&H 2650CX shovels uses the SR Hybrid Drive system to offer reduced fuel consumption and greenhouse gas emissions and increased longevity by regenerating power. For instance, the power generated from the bucket lowering process is captured and used to power the machine. During this state, fuel supply is shut off and there is no engine load, contributing to longer engine life.

Pros and cons: hybrid shovel

Pros

- Combines advantages of rope shovels and hydraulic excavators
- Tech and parts commonality to Komatsu hybrid wheel loaders
- Maintenance-friendly design
- Lowest diesel-powered cost-per-ton product
- Low fuel consumption
- Low greenhouse gas emissions
- Double-sided loading
- Mobility (not restricted by electrical grid)
- Selective digging
- Metered dump and no dipper latch system
- Tight loading materials
- Tight loading area
- Reduced transportation and assembly costs

Cons

- Moderate capital cost (slightly more than hydraulic excavators)
- New product, limited size offerings
- Excessive tramming
- Clean-up support
- Low face
- Multiple faces

P&H 2650CX

Nominal payload: 59 mt (65 st)

Nominal dipper capacity:
31.1 m³ (40.7 yd³)



Wheel loaders

A wheel loader (commonly referred to as a loader or front-end loader) is a useful part of any fleet. It can be utilized for initial mine development or pre-production work and as either a primary or a back-up production machine. Wheel loaders are very versatile, making them essential to any mine plan.

Komatsu wheel loaders are available with either mechanical or electrical drive systems. The Komatsu electrically-driven wheel loaders utilize SR Hybrid Drive technology that reduces fuel consumption, reduces carbon emissions, reduces engine load and can improve productivity by reducing cycle times.

Key operational requirements for wheel loaders include good floor maintenance, adequate draining of the loading area and wheel loader- optimized blast design to ensure proper fragmentation. Because of the limited breakout forces compared to other loading tools, wheel loaders generally require better material fragmentation to achieve high productivity.

Wheel loaders are popular in applications requiring blending operations, surge pile loading, road and infrastructure construction, working in the confined space of a drop cut and support or backup for larger excavators or shovels.

Wheel loaders excel in situations where mobility is critical – multiple face operations with frequent relocations and as a backup for multiple loading tools. They do not work well in applications with wet or soft floor conditions.

To achieve full bucket fill, wheel loaders are most productive at face heights of at least three times the bucket height. Because of their ability to drive, wheel loaders can also be used on lower bench heights but will “chase” the material, resulting in slower cycle times. Wheel loaders are also capable of providing clean-up of the loading area and are preferred when digging in tailings or low bench height scenarios.

WA800

Bucket size: 12m³
Weight: 102 t
54 – 100 st trucks



WA900

Bucket size: 13m³
Weight: 107 t
54 – 160 st trucks



WA1200

Bucket size: 20m³
Weight: 216 t
144 – 250 st trucks





Pros

- Low capital cost relative to other loading tools
- Mobility for multiple face loading and blending operations requiring frequent tramming
- Level, dry, smooth, firm floor conditions
- Able to maintain floor conditions without additional support equipment
- Well-fragmented materials that minimize bucket fill time, especially in the toe-area of the shot
- Hybrid wheel loader having similar operating costs to HEX
- Multiple face profiles

Cons

- High operating costs (particularly mechanical drive)
- Poorly fragmented materials, increased bucket fill times
- Underfoot conditions – soft, wet, jagged

L-1150

Bucket size: 19m³
 Weight: 141 t
 150 – 205 st trucks



L-1350

Bucket size: 23m³
 Weight: 184 t
 150 – 250 st trucks



L-1850

Bucket size: 30m³
 Weight: 243 t
 205 – 320 st trucks



L-2350

Bucket size: 40m³
 Weight: 267 t
 240 – 400 st trucks



Loading tool selection guide



Single-sided loading

The most common rope shovel, hydraulic excavator or wheel loader operating method is single-sided loading. For single-sided loading, haul trucks are loaded on one side of the loading tool. Advantages of single-sided loading include relatively small footprint and minimal traffic pattern coordination, but the loading tool generally will need to wait during truck exchange, thus limiting production levels.

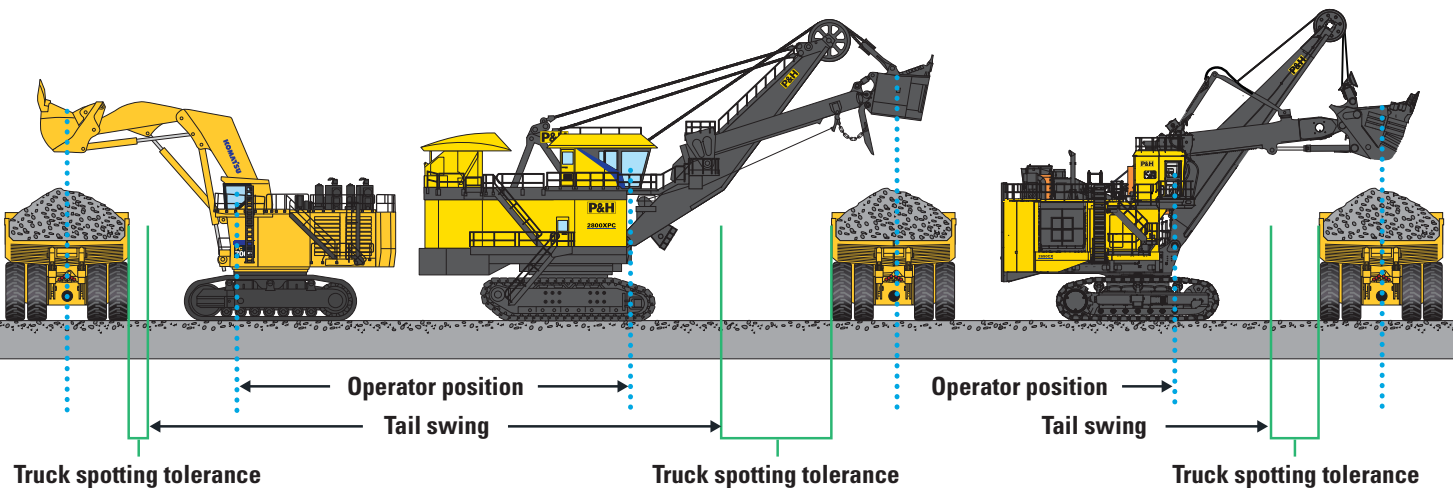

Figure 1 Truck spotting



Double-sided loading

Double-sided loading, where trucks load on both sides of the loading tool, can increase production but requires additional considerations:

- Loading tool and haul truck compatibility for double-sided loading (loading tool tail swing should not interfere with truck spotting)
- Larger working face
- Possibility for more truck queuing areas
- Twice the cleanup support required
- Cable bridge needed for electric powered machines
- Larger footprint may require larger bench width

Loading tool selection guide

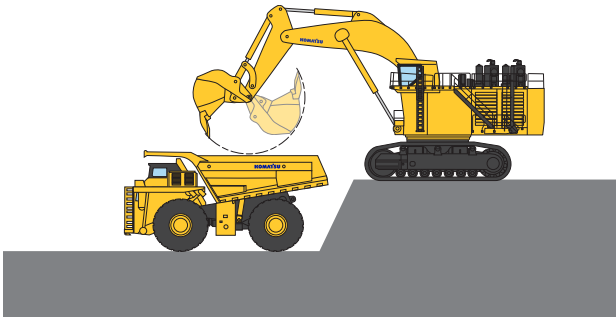

- Bench height: approximately 15 ft. (4.5 m)
- Swing: 30°-60°
- Production efficiency:* approximately 3% more

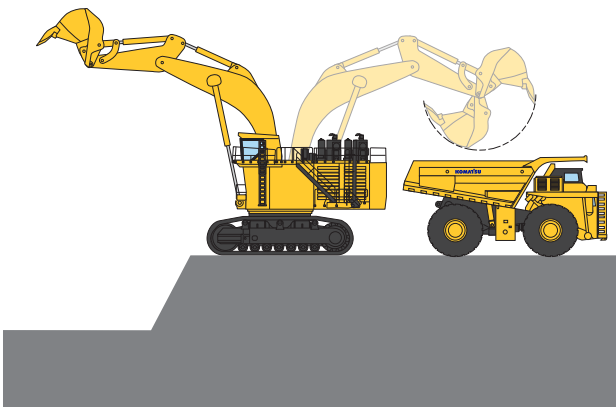

- Bench height: approximately 15 ft. (4.5 m)
- Swing: 90°-180°
- Production efficiency:* approximately 17% less

Front shovel or backhoe configuration?

Here are some things to factor when considering a front shovel or backhoe configuration:

- Backhoe can be more productive because of reduced cycle times, if lower level loading
- Backhoe requires more extensive mine planning, such as more benches and increased traveling
- Front shovel configuration recommended for electric powered hydraulic excavators
- Reduced bench height for backhoe configuration allows working in unstable materials
- If floor conditions are poor, backhoe can operate on upper level, reducing wear on excavator and truck
- Personal preference

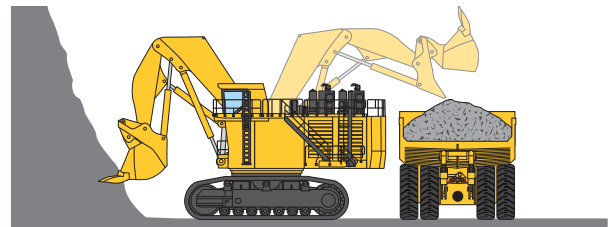

- Bench height: up to 50 ft. (15 m)
- Swing: 60°-90°
- Production efficiency:* 100%

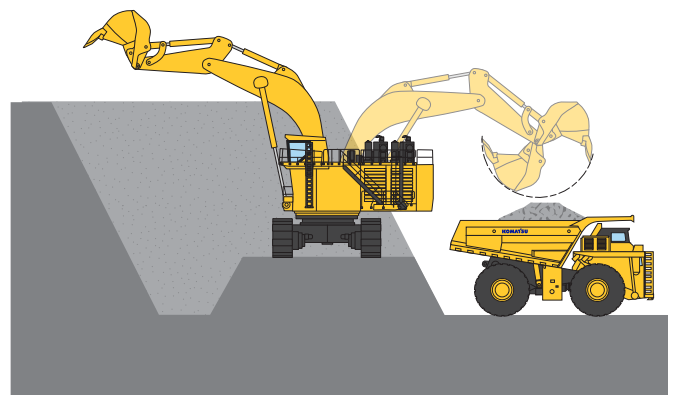

- Bench height: approximately 50 ft. (15 m)
- Swing: 30°-180°
- Production efficiency:* approximately 8% less

* Estimated rates - reference purposes only Bench height and swing angle depend on machine size and site conditions.



Wheel loader loading style

Position truck at recommended angle to minimize loader maneuver and cycle time as well as wear.

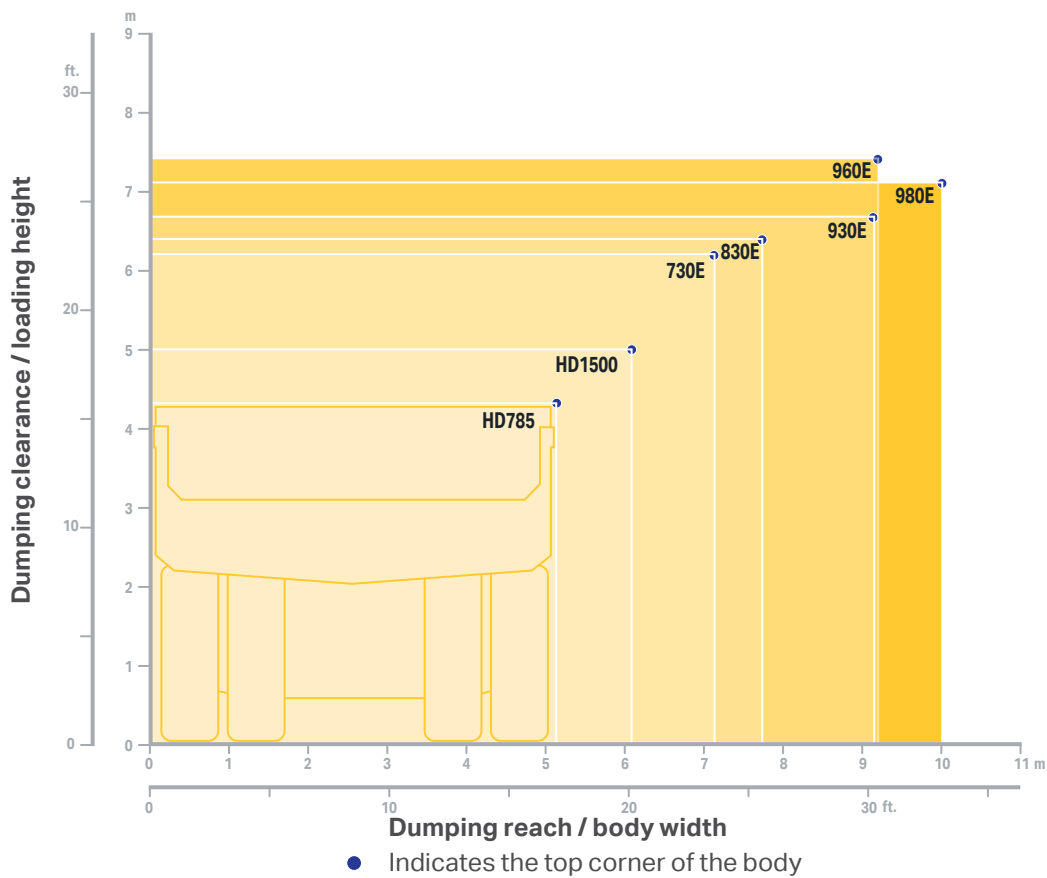
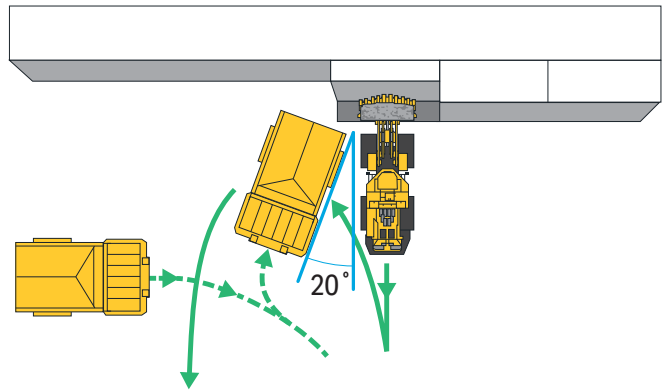

Figure 2 Komatsu mining trucks with standard bodies

As a general reference, the above chart overlays all Komatsu mining trucks equipped with standard bodies. Please note that there are several truck body manufacturers and haul truck width and height can vary significantly depending on truck body design.

Bench height design



Electric rope shovels

P&H shovels require a face height of about 50% of their point sheave height – basically the height of the teeth when the dipper stick is horizontal. However, they can operate at higher bench heights than wheel loaders and hydraulic shovels, reducing other operating costs. A higher face means fewer benches, fewer relocations, and lower drill- and-blast costs.

	Typical bench height
P&H 1900XPC AC	8-12 m (26-40 ft.)
P&H 2300XPC AC	8-12 m (26-40 ft.)
P&H 2800XPC AC	9-18 m (30-60 ft.)
P&H 4100XPC	10-20 m (33-66 ft.)
P&H 4100C Boss AC	10-20 m (33-66 ft.)
P&H 4800XPC	12-21 m (40-69 ft.)()



Hybrid shovel

Similar bench height considerations to electric rope shovels.

	Typical bench height
P&H 2650CX	6-16m (20-50 ft.)



Hydraulic excavator

Shovels: Most efficient bench height at 75% of maximum digging height

Backhoes: Bench height ~ stick length

	Typical bench height
PC3000 FS Diesel/Electric	12-15 m (40-50 ft.)
PC3000 Backhoe	5 m (16 ft.)
PC4000 FS Diesel/Electric	12-15 m (40-50 ft.)
PC4000 Backhoe	5 m (16 ft.)
PC5500 FS Diesel/Electric	12-16 m (40-52 ft.)
PC5500 Backhoe	5 m (16 ft.)
PC7000 FS Diesel/Electric	12-17 m (40-56 ft.)
PC7000 Backhoe	5 m (16 ft.)
PC8000 FS Diesel/Electric	12-18 m (40-60 ft.)
PC8000 Backhoe	5 m (16 ft.)



Wheel loader

Bench height minimums recommended at least 2-3 times the bucket height for most production.

	Typical bench height
WA800	6-15 m (20-50 ft.)
WA900	6-15 m (20-50 ft.)
WA900 HL	6-15 m (20-50 ft.)
WA1200	6-15 m (20-50 ft.)
WA1200 HL	6-15 m (20-50 ft.)
L-1150	6-15 m (20-50 ft.)
L-1150 HL	6-15 m (20-50 ft.)
L-1350	6-15 m (20-50 ft.)
L-1350 HL	6-15 m (20-50 ft.)
L-1850 Standard	6-15 m (20-50 ft.)
L-1850 HL	6-15 m (20-50 ft.)
L-2350	6-15 m (20-50 ft.)
L-2350 HL	6-15 m (20-50 ft.)

Loading tool selection guide

Material characteristics

Material	Bank		Loose		Swell factor	Fillability	Digability
	lbs/bcy	kg/bcm	lbs/lcy	kg/lcm			
Asbestos ore					1.40	0.85	M
Basalt	4,970	2,949	2,870	1,703	1.60	0.80	H
Bauxite	3,200	1,898	2,390	1,418	1.35	0.90	M
Chalk					1.30	0.85	M
Clay							
Dry					1.25	0.85	M
Light					1.30	0.85	M
Heavy					1.35	0.85	M-H
Clay and gravel							
Dry					1.30	0.85	M
Wet					1.35	0.80	M-H
Coal							
Anthracite (washed)			1,690	1,003	1.35	0.90	M
Bituminous			1,500-1,600	890-949	1.35	0.90	M
Sub-bituminous			1,400-1,600	831-949			
Lignite			1,800-2,000	1,068-1,187	1.30	0.90	M
Copper ores							
Low grade					1.50	0.85	M-H
High grade					1.60	0.80	H
Earth							
Dry	3,030	1,798	2,360	1,400	1.30	0.95	E
Wet	3,370	1,999	2,700	1,602	1.30	0.90	M
Loam	2,600	1,543	2,110	1,252			
Granite	4,720	2,800	2,700	1,602	1.55	0.80	H
Gravel (Pitrun)	3,660	2,171	3,250	1,928	1.25	1.00	E
Gypsum	5,340	3,168	3,050	1,809	1.50	0.85	M
Hematite, iron ore	5,900	3,500	4,700	2,788	1.55	0.75	H
Limestone	4,720	2,800	2,700	1,602	1.60-1.50	0.80-0.85	M-H
Magnetite, iron ore	6,400	3,797	4,890	2,901	1.65	0.75	H
Sand							
Dry	2,700	1,602	2,390	1,418	1.15	1.00	E
Damp	3,200	1,808	2,850	1,691	1.15	1.00	E
Wet	3,500	2,076	3,100	1,839	1.15	1.00	E
Sand and gravel							
Dry	3,250	1,9282	2,900	1,721	1.15	1.00	E
Wet	3,760	2,231	3,400	2,017	1.15	1.00	E
Sandstone	4,550	2,699	2,610	1,548	1.60	0.80	M-H
Shale	2,800	1,661	2,100	1,246	1.45	0.80	M-H

Digging flexibility with clamshell buckets

Hydraulic excavator and hybrid shovels provide a high degree of digging flexibility and can generally produce high digging forces lower in the bank. Due to their hydraulically operated clamshell bucket, these machines can operate with flexible digging paths, allowing for horizontal digging along the floor, top-down digging, and selective digging — which is a potential requirement in hard rock, multi-seam coal, or banded iron formations.

Operators commonly use the top to bottom method which allows the operator to not only selectively dig but also to decrease cycle times.

Digging material layer by layer
Excavator

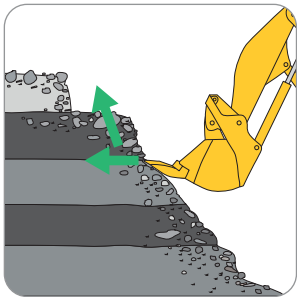

Hybrid shovel

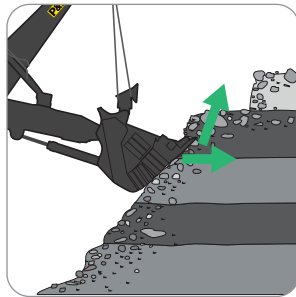

Selective Digging
Excavator

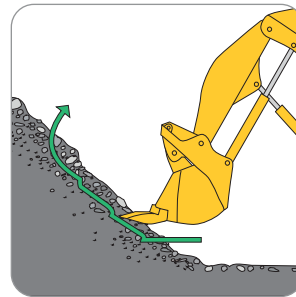

Hybrid shovel

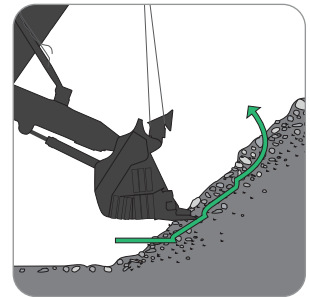

Digging horizontally along floor
Excavator

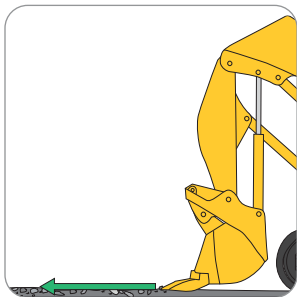

Hybrid shovel

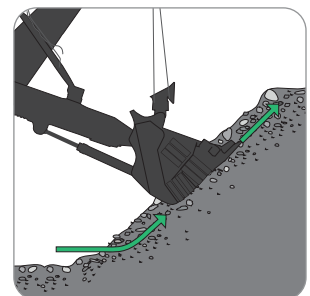
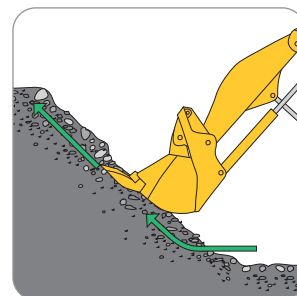
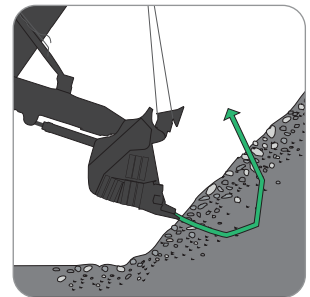
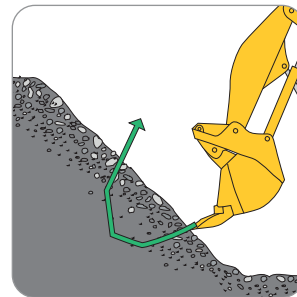
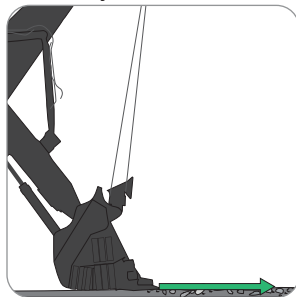

Figure 3 Digging flexibility

Mobility



Shovels requiring electric grid

P&H electric rope shovels / electric-drive hydraulic excavators

Electric rope shovels and electric-drive hydraulic excavators have limited mobility. These products are powered by a high voltage trail cable tethered to the electric grid. Advantages for the trail cable include lower operating costs and environmental friendliness; however, these units require trail cable management and relocations are generally arranged in advance.



Diesel-powered shovels

Hydraulic excavators / P&H hybrid shovels

The mobility of diesel-powered hydraulic excavators and hybrid shovels is in between the other loading products. Compared to wheel loaders, these machines have slower travel speeds and reduced mobility. Compared to electric rope shovels, diesel-powered shovels offer better mobility, because they are not tethered to a trail cable. Additionally, their reduced weight allows for slightly quicker travel speeds. Note: If frequent relocations are necessary, but a wheel loader does not meet other selection criteria, a low-boy, or float transporter, extends the relocation capability of hydraulic/hybrid shovels.



Wheel loaders

If mobility is important to a mine site, the best choice is often a wheel loader. The wheel loader can provide a production tool for operations with multiple faces or blending between multiple stockpiles, and quickly relocating during a blast. The loader can assist as a back-up unit to multiple loading tools and clean-up machine. Additionally, the loader performs support roles of building berm, diffing ramps and maintaining haul roads.

Power supply requirements

There are specific mine requirements necessary to operate an electric shovel. All P&H rope shovels are equipped with full electric drive systems and are either AC or DC depending on the model. Komatsu hydraulic excavators may also be electrically powered depending on site location and preference.

Electric powered shovels require an available electrical grid (power lines to the pit) and power substations at the mine site. The electrical grid must be reliable and provide adequate voltage during peak usage. Depending on the different shovel models, if the voltage supplied is above the recommended supply limits the main transformer will reduce the voltage to the appropriate level. The main transformer supplies the converter cabinet and, in turn, powers the motion motors. There is also an auxiliary transformer that steps down the high voltage from the trail cable to power the auxiliary systems such as the motor fields, relays, and lighting supplies. The electrical power supplied to the various shovel models may be as low as 2,400 volts for the 1900AL model and as high as 13,800 volts for a 4100XPC with 3-phase at 60 hertz.

The power is supplied to the machines by means of a well-insulated trail cable and enters the shovels through the lower assembly or carbody, in the back of structure. The trail cable can conduct high voltage electricity for hundreds of meters. The cable gauge depends on the shovel model and power supply. Trail cables must be able to withstand mine site weather and working conditions. Trail cables may limit mobility of the shovel and haul trucks so proper planning is essential to avoid damage. Automatic cable reels located on the shovel and portable cable racks are available, and additional equipment may be needed to move the cable as the shovel moves.

To ensure safety and reliability, the cable should be inspected and maintained on a regular basis and may need to be replaced in some cases.

Note: Position the cable from the shovel in a direct line to the cable bridge where the haul trucks exit. This will improve operation layout and will reduce the risk of the cable being run over by trucks.

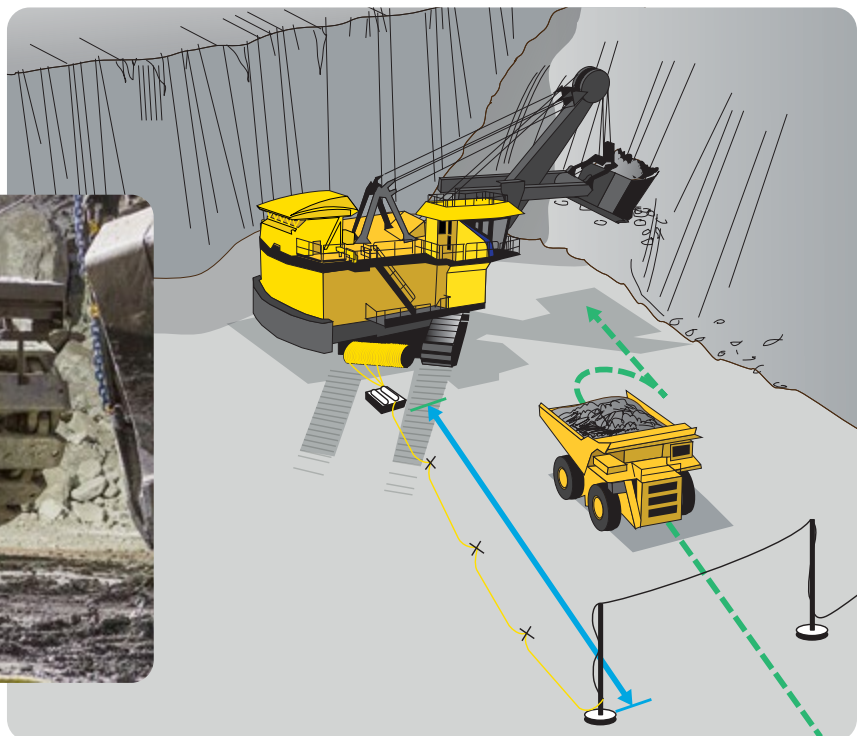

Figure 4 Trail cable positioning

Floor conditions

All loading equipment operates best on dry, smooth, level, and firm floors; but these conditions are not always present in mining. Floor conditions at a mine should be considered when selecting a loading tool.

Wheeled considerations

Key operational requirements for wheel loaders include good floor maintenance, adequate draining and clearing of rocks in the loading area to prevent tire damage, and level floor grades. Without these conditions, wheel loader production may decrease and operating costs increase.

Tracked considerations

Tracked loading tools, such as hydraulic excavators, hybrid shovels, and electric rope shovels are often better suited for adverse floor conditions, such as wet, jagged/rolling, pitched, or soft/spongy. Tracked machines often have standard and optional track shoe widths available. In general, the narrowest shoes are the most durable choice. A wider shoe provides better flotation for applications with a soft/spongy floor but durability and steerability may decrease. Tracked loading tools generally rely on auxiliary equipment to prepare the ground conditions, which also helps them operate in adverse floor conditions.

Weights/ground bearing pressures

Hydraulic excavators are designed to minimize structural weight, providing reduced ground bearing pressure and increased mobility.

Electric rope shovels have robust designs to provide maximum durability, stability and longevity. They also weigh more than hydraulic excavators of equal weight. Electric rope shovels are less prone to being pushed back during digging, thus requiring less repositioning.

Wheel loader



Electric rope shovel / hybrid shovel / excavator

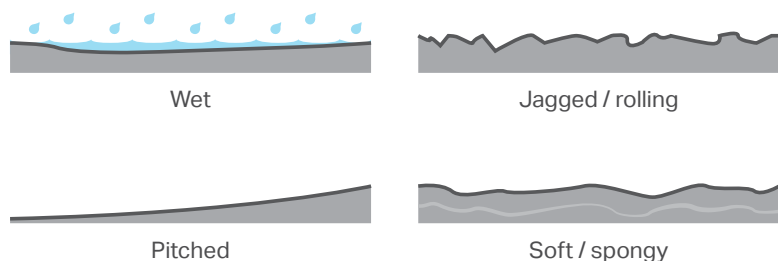

Figure 5 Floor conditions

Model	Trim	Operating weight		Ground Pressure	
		kg	lbs	N/cm ²	psi
PC2000-11	Backhoe	201,930	445,179	19.2	27.9
PC3000-11	Front shovel	257,000	566,588	15.9-23.4	23.1-33.9
	Backhoe	264,000	582,020	16.1-23.7	23.4-34.4
PC4000-11	Front shovel	397,982	877,400	17.5-21.8	25.4-31.6
	Backhoe	409,004	901,700	17.7-22.2	25.7-32.2
PC5500-11	Front shovel	537,000	1,183,882	18.1-23.5	26.2-34.0
	Backhoe	542,000	1,194,905	18.3-23.8	26.5-34.5
PC7000-11	Front shovel	678,000	1,494,734	20.0-25.0	29.0-36.2
	Backhoe	696,000	1,534,417	20.3-25.3	29.4-36.6
PC8000-11	Front shovel	769,000	1,695,354	21.9-27.3	31.7-39.6
	Backhoe	790,000	1,741,651	22.1-27.5	32.0-39.9
WA800-8	Std boom	115,530	254,700		
WA900-8	Std Boom	116,400	256,618		
	High lift boom	116,720	257,324		
WA1200-6	Std boom	217,800	477,100		
	High lift boom	219,700	481,300		
L1150-2	SL	140,614	310,000		
L1150-2	HL	141,974	313,000		
L1350-3	SL	194,228	428,200		
L1350-3	HL	196,496	433,200		
L1850-2	SL	242,672	535,000		
L1850-2	HL	246,370	543,000		
L2350-2	SL	266,622	587,800		
L2350-2	HL	272,065	599,800		
2650CX		805,000	1,774,300		
1900XPC		379,000	835,000	24.1 – 29.6	35.0 – 43.0
2300XPC AC		775,000	1,709,000	23.0 – 26.1	33.4 – 37.9
2800XPC AC		1,079,000	2,379,000	28.8 – 38.1	41.8 – 55.3
4100C		1,243,300	2,741,000	34.5 – 44.2	50.1 – 64.1
4100XPC AC-90		1,249,000	2,753,000	30.8 – 35.1	44.7 – 51.0
4100C BOSS		1,354,000	2,985,000	36.0 – 41.2	52.2 – 59.7
4100XPC AC		1,532,000	3,378,000	38.0 – 43.4	55.1 – 63.0
4800XPC		1,661,500	3,663,000	38.3 – 43.9	55.6 – 63.7

Figure 6 Operating weight and ground pressure

Loading tool selection guide



Clean-up support considerations

Auxiliary equipment is required to clean-up spilled material and to maintain floor levels during loading processes. Different mining operations will have different support fleets for clean-up and other general tasks. The optional support equipment could include dozers and wheel loaders. The wheel loaders can be used for clean-up, reloading material, scaling in some cases, and as a backup production loading tool if required.

Maintaining floor clean-up is very important as it will prevent equipment damage to the shovel and haul trucks. The cleanup should not interfere with the truck loading process and should be performed before the next operator starts positioning the truck for loading.



Drilling and blasting

Regardless of the machine, loading tools perform better in well-blasted material. Drilling and blasting typically accounts for only 15% of the cost of primary mining operations and only 6% when the mining and processing operations are considered. Mining operations understand the value of effective drilling and blasting to maximize productivity.

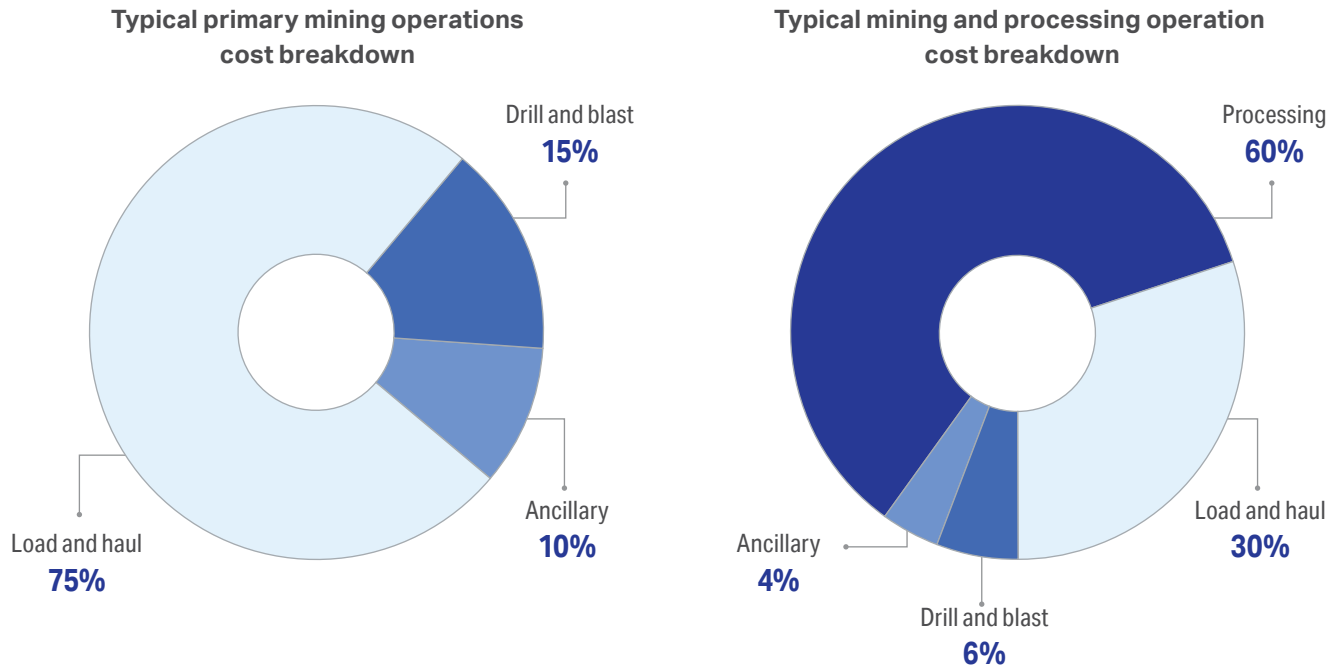

Figure 6 Typical mining cost break down

ZT44

Hole diameter:
140 mm - 216 mm
(5.5 in. - 8.5 in.)

Single pass:
6.1 m (20 ft.)
plus drill string

Multi pass:
42.7 m (140 ft.)
(Up to 4.5 in. pipe)
30.5 m (100 ft.)
(Up to 5.5 in. pipe)



77XR

Hole diameter:
200 mm - 270 mm
(7 7/8 in. - 10 5/8 in.)

Single pass:
16.8 m (55 ft.)

Multi pass:
85 m (280 ft.)



ZR122

Hole diameter:
270 mm - 349 mm
(10 5/8 in. - 13 3/4 in.)

Single pass:
19.8 m
(65 ft.)

Multi pass:
85 m
(280 ft.)



320XPC

Hole diameter:
270 mm - 444 mm
(10 5/8 in. - 17 1/2 in.)

Single pass:
19.8 m (65 ft.)
(standard)

21.3 m (70 ft.)
(optional)

Multi pass:
39.6 m (130 ft.)
(single pipe rack)
59.4 m (195 ft.)
(dual pipe rack)



Loading tool selection guide



Matching loading tools to Komatsu haul trucks

Selecting a loading tool involves determining the number of passes required to load a haul truck.

The table shown to the right provides a general Komatsu pass-matching combination. Komatsu recommends targeting 3-6 passes for the loader/hauler combination, as this provides an optimum fleet cost-per-ton. Exceeding this pass-match can reduce a loading tool's ability to load a haul truck and may decrease production capabilities. Less than three passes means more trucks are required to keep the loader in production, which can lead to higher operating costs, more truck exchanges, and more congestion.

Loose material density and bucket fill factors are crucial to the selection process and directly influence dipper

and bucket sizing for a loading tool. Loose material density is the material weight per unit of volume after blasting (or after free-digging if blasting is not required). Komatsu has experienced Mining Application Engineers knowledgeable on assisting sites in recommending dipper and bucket sizes. As a reference, the Material Characteristics table includes a chart for material density characteristics.

Avoid partial passes:

In loader-dependent applications, it is not recommended to complete a partial pass to load a truck to its rated payload. Partial passes decrease production capabilities.

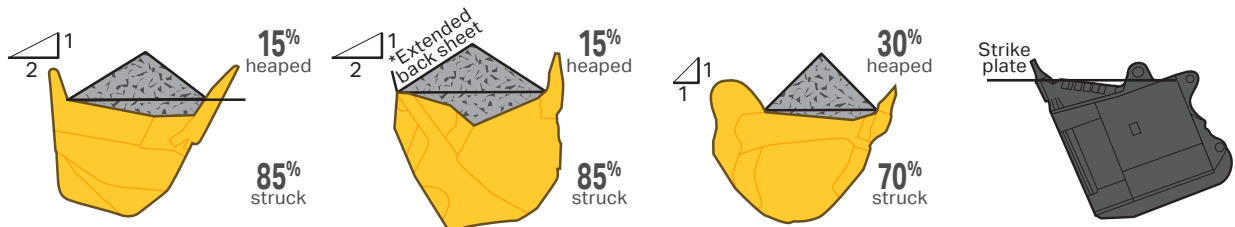

Machine	Wheel loader	Front shovel	Backhoe	Cable shovel
Rating methodology	Struck + heaped capacity Heaped capacity = 2:1 slope	Struck + heaped capacity Heaped capacity = 2:1 slope	Struck + heaped capacity Heaped capacity = 1:1 slope	Struck + heaped capacity (2:1) Normal OEM figures reflect struck capacity only
Comments	Struck = % of rated SAE J296 guideline Slope termination points are the cutting edge and the top of the back sheet	Struck = % of rated SAE J296 guideline Slope termination points are the cutting edge and the top of the back sheet	Struck = % of rated SAE J742b guideline Slope termination points are the cutting edge and the top of the back sheet	Struck capacity equals a strike plane from the cutting edge to the top of the bucket

*An extended back sheet may be included in bucket capacity rating if it is an integral part of the bucket. If included this may impact struck versus heaped capacity.

Figure 7 Bucket capacity

Loading tool selection guide

Pass match	HD785	HD1500	730E	830E	930E	960E	980E
1900XPC	5	8					
2300XPC		3	4	5	6	7	8
2800XPC			3	4	5	5	6
4100XPC AC-90				3	3	4	4
4100C BOSS					3	3	4
4100XPC AC110					3	3	3
4100XPC AC 120						3	3
4800XPC							3
2650CX			3	4	5	5	6
PC2000 BH D	4	7					
PC3000 FS E	3	5	7	8			
PC3000 FS D	3	5	7	8			
PC3000 BH D	3	5	7				
PC4000 FS E	3	4	5	6	8		
PC4000 FS D	3	4	5	6	8		
PC4000 BH D	3	4	5	6	8		
PC5500 FS E		3	3	4	6	6	7
PC5500 FS D		3	3	4	6	6	7
PC5500 BH D		3	3	4	6	6	7
PC7000 FS E			3	3	4	5	5
PC7000 FS D			3	3	4	5	5
PC7000 BH D			3	3	4	5	5
PC8000 FS E				3	4	4	5
PC8000 FS D				3	4	4	5
PC8000 BH D				3	4	4	5
WA800	5						
WA900	4						
WA900 HL	5	8					
WA1200	3	5					
WA1200 HL	3	5	7				
L-1150	3	5					
L-1150 HL	3	5	7				
L-1350		4	5	6			
L-1350 HL		4	5	7			
L-1850		3	4	5	6		8
L-1850 HL		3	4	5	7	8	8
L-2350			3	3	4		6
L-2350 HL			3	4	5	5	6

Figure 8 Truck matching chart

Typical cycle times

The work cycle has four distinct phases:

1. Digging
2. Swinging or traveling to truck
3. Dumping
4. Returning

The sum of these four phases make up a cycle time. The type and size of the loading tool (electric rope shovel, hybrid shovel, wheel loader or hydraulic shovel) will often dictate expected cycle times – the time required to load one pass into the truck. Generally, however, cycle times will fall in the range of 24 to 50 seconds.

For reference and planning purposes, the following nominal cycle time figures are suitable for general use:

- Electric cable shovel: 29 – 35 seconds for a 70° swing angle,
- Hydraulic front shovel: 25 – 33 seconds for a 70° swing angle,
- Hydraulic backhoe shovel: 24 – 32 seconds for a 45° - 70° swing angle,
- Hybrid shovel: 25 – 33 seconds for a 70° swing angle,
- Wheel loader: 28 – 50 seconds for blasted working face

Load times will vary based on application and material characteristics. If the digging cycle takes more than half of the total cycle time, it could be an indication that an operator could use additional training or that the material is not well-suited for the loading tool.

The swing phase generally represents the largest part of the entire cycle time and should be kept to a minimum by reducing the swing arc, if applicable. Keeping the swing arc as narrow as possible will help enhance operating efficiency. Figure 9 shows the range of swing arcs and the productivity associated with the different angles. A swing arc of 70° is considered standard and represents 100% of optimum output. For tracked loading tools, nominal times can be adjusted for varying swing angles by using the following industry guideline: 1 second for each 10° increase or decrease in average swing angle.







Swing angle, degrees	Impact on production, %
 45	126
 50	116
 60	107
 70	100
 100	88
 130	77
 180	70

Figure 9 Swing angle impact on production

Hourly production estimation (tonnes/hour)

Pass match	HD785	HD1500	730E	830E	930E	960E	980E
1900XPC	1420	1500					
2300XPC		3249	3431	3550	3634	3696	3745
2800XPC			4230	4466	4621	4621	4731
4100XPC AC-90				5541	5712	6023	6023
4100C BOSS					6346	6346	6691
4100XPC AC110					6981	6981	6981
4100XPC AC 120						7612	7612
4800XPC							8562
2650CX			4294	4541	4703	4703	4817
PC2000 BH D	1543	1719					
PC3000 FS E	2027	2313	2462	2513			
PC3000 FS D	2027	2313	2462	2315			
PC3000 BH D	1952	2236	2385				
PC4000 FS E	2280	2936	3087	3197	3345		
PC4000 FS D	2280	2936	3087	3197	3345		
PC4000 BH D	2341	3020	3181	3297	3455		
PC5500 FS E		3402	3402	3665	3972	3972	4069
PC5500 FS D		3402	3402	3665	3972	3972	4069
PC5500 BH D		3488	3488	3765	4089	4089	4193
PC7000 FS E			4433	4570	4933	5180	5180
PC7000 FS D			4433	4570	4933	5180	5180
PC7000 BH D			4548	4689	5071	5332	5332
PC8000 FS E				4589	4917	4917	5138
PC8000 FS D				4589	4917	4917	5138
PC8000 BH D				4696	5041	5041	5273
WA800	1219						
WA900	1362						
WA900 HL	1269	1383					
WA1200	1805	2052					
WA1200 HL	1637	1860	1976				
L-1350		2406	2538	2634			
L-1350 HL		2246	2370	2528			
L-1850		2569	2761	2890	2983		3109
L-1850 HL		2356	2532	2651	2801	2851	2851
L-2350			3192	3192	3413		3666
L-2350 HL			2990	3196	3335	3335	3434

Figure 10 General production chart (tonnes/hour) single-side, loader dependent application

The above chart reflects a general hourly production reference in a loader dependent application (i.e. a truck is always present). No mine site is the same, and likewise, production will vary depending on the application and site conditions. Production figures for a specific site may be significantly higher or lower than listed above.

Commercial considerations

Costs generally associated with loading equipment are described as ownership and operating (O&O) costs. Costs for purchase and operation of mining equipment vary widely depending on the commissioned price, finance charges, operating performance, application conditions, local fuel and lubricant prices, parts availability and prices, ground engaging tools (GET), local labor availability, skills, and wages and more. Reliable cost estimates must be based on an accurate assessment of mining conditions and current local data. Thus, most industry methods presented for cost estimating are general and suitable for reference purposes only.

Ownership and operating costs may be presented as annual or hourly costs. Hourly costs usually are based on actual operating time.

Owning costs:

The equipment owning cost is the expense required for the purchase and possession of the loading tool as a property of its owner. It consists of the following items:

1. Depreciation
2. Interest, insurance, and taxes

Operating costs:

Loading tool operating costs are proportional to the time that the equipment works. It consists of the following items:

1. Fuel/Energy. Varies based on application and local costs.
2. Lubricants (oil and grease), filters, and periodic maintenance labor. Can measure the consumption of lubricants and grease in a similar manner to fuel consumption.
3. Tires (for wheel loaders). Includes tire replacement and repair costs based on tire life.
4. Repairs. Typically includes all component maintenance expenditures not considered preventive maintenance. This includes both parts and labor for overhauls and rebuilds.
5. Wear items. Dippers and buckets are equipped with liner packages that require specific budgeting attention. At the cutting edge, ground engaging tools, also known as GET, are the primary component for material penetration and are replaced relatively often, depending on the application.
6. Operator Wage. Varies by region.



Ownership and operating costs, in conjunction with fleet production, are typically used to determine loading tool production cost. A common way to compare loading tools is on a cost-per-tonne or m³ (ton or yd³). This analysis has various possible techniques, so it is important for inputs to be similar when comparing equipment.

A description of each loading tools cost characteristics are summarized below.

- Electric rope shovels. The lowest cost-per-unit option throughout a 20-year period. This product is high capital cost and requires electric grid infrastructure to operate.
- Hydraulic excavators (diesel). The highest volume of mining equipment in the industry. These units are moderate capital cost, flexible and capable of high production. In general, fuel consumption leads to higher operating costs.
- Hydraulic excavators (electric). Similar capital cost to diesel-powered hydraulic excavators. These units are often the lowest cost-per-unit over a 10-year period, particularly if considering time value of money. Like a rope shovel, these units require electric grid infrastructure.
- Hybrid shovels. The lowest diesel-powered cost-per-unit loading tool offered by Komatsu. Hybrid shovels are moderate capital cost and show a promising future in the mining industry due to their sustainability and flexibility.
- Hybrid wheel loaders. Moderate-low capital cost. Reduced fuel and mechanical componentry versus mechanical drive wheel loaders. A low cost-per-unit loading option. Useful for multiple faces, blending, or other versatile mining needs.
- Mechanical drive wheel loaders. Lowest capital cost of all loading equipment but higher cost-per-unit. Useful for multiple faces, blending, or other versatile mining needs.

Loading tool selection guide

Summary

	Wheel loader	Hydraulic excavators
Capex	Low-moderate capital cost	Moderate capital cost
Operating costs	Mechanical drive wheel loaders are typically the highest operating cost machines, particularly if tire wear is high	Medium-low operating costs for electric-powered hydraulic excavators. High operating costs for diesel-powered hydraulic excavators
Cost-per-ton	Hybrid wheel loaders offer a competitive cost-per-ton to electric-powered hydraulic excavators and hybrid shovels	Electric-powered hydraulic excavators are lowest cost-per-ton over 10-year period
Bench heights	Most efficient bench height at 75% of maximum digging height	Most efficient bench height at 75% of maximum digging height
Underfoot conditions	Tires make unit susceptible to soft underfoot	Lowest static ground pressure for use in soft underfoot conditions. Backhoe configuration offers digging and loading on upper level.
Returning to dig face	Bucket must be lowered to ground level to begin dig cycle for most efficient operation	Hydraulic-powered bucket does not require bucket lowering to the ground to begin dig cycle. Can enter digging face at any level.
Digging flexibility	Wide bucket and the need to return to ground level to dig limit to mine selected layers or pocket of material	Ability to dig from the top down by penetrating the loading face at some level above ground. Can selectively mine layers or pockets of material
Lifetime hours	60,000+ hours	60,000+ hours
Relocation	Easy transportation and assembly so loader can be moved between operations	Can be disassembled and reassembled on a different site relatively quickly
Training	Relatively simple technical training and tooling required	Some specialized training and tooling required
Blasting	Requires very good blasting in order to allow bank penetration and good productivity	Ability to load from the top down provides ability to handle poorly blasted material
Typical cycle times	Typical cycle times of 28 to 50 seconds	Typical cycle times of 25 to 35 seconds. Backhoe configured units capable of quickest cycle times in lower-level loading applications.
Mobility	Mobility provides excellent loading area cleanup	Mobility to move between faces, but not enough for blending operations
Greenhouse gas emissions	Hybrid wheel loaders offer less greenhouse gas emissions than mechanical drive	Electric-powered option available to reduce greenhouse gases. More greenhouse gas emissions are produced with diesel-powered units
Support equipment	Support equipment not needed	Can use reach of front attachment to keep floor of loading area clean (but production can be interrupted)
Used equipment market	Very strong used market for good quality wheel loaders	Good used equipment market for hydraulic excavators

Hybrid shovels

Electric rope shovels

Moderate capital cost	High capital cost
Lowest diesel-powered shovel	Lowest operating costs
Lowest diesel-powered cost-per-unit	Lowest cost-per-unit over 20-year period
Most efficient digging height with bench height equal to boom point height	Most efficient digging height with bench height equal to boom point height
Good ground pressure; optional track widths and lengths can reduce to a significantly lower level than base unit	Good ground pressure; optional track widths and lengths can reduce to a significantly lower level than base unit
Hydraulic-powered bucket does not require bucket lowering to the ground to begin dig cycle	In order to close dipper door, dipper must return to ground level to start dig cycle
Ability to dig from the top down by penetrating the loading face at some level above ground. Can selectively mine layers or pockets of material	Difficult to mine selectively because of requirement to return to ground level to begin dig cycle
90,000+ hours	120,000+ hours
Modular design. Can be disassembled and reassembled quicker than rope shovels but not as quick as hydraulic excavators	Lengthy process for disassembly, relocation, and reassembly
Some specialized training and tooling required	Requires specialized technical training and tooling
Ability to load from the top down provides ability to handle poorly blasted material	Best suited to work with well-blasted material but can handle more poorly blasted material as well
Typical cycle times of 25 to 33 seconds.	Typical cycle times of 29 to 35 seconds.
Mobility to move between faces, but not enough for blending operations	Lack of mobility due to connection to electric grid system
Low greenhouse gas emissions due to power regeneration	Most environmentally friendly because of power supplied by electric trail cable
Can use reach of front attachment to keep floor of loading area clean (but production can be interrupted)	Typically uses a loader or rubber-tired dozer to keep floor of loading area clean
New offering with very limited used equipment market	Limited used equipment market for electric rope shovels due to transportation and reassembly requirements

Product designs, specifications and/or data in this document are provided for information purposes only and are not warranties of any kind. Product designs and/or specifications may be changed at any time without notice. The only warranties that apply to sales of products and services are Komatsu's standard written warranties, which will be furnished upon request.

Komatsu and other trademarks and service marks used herein are the property of Komatsu Ltd. Or its subsidiaries, or the respective owners or licensees.

KOMATSU

[komatsu.com](https://www.komatsu.com)

